



23  
24

NOVELTIES

LICHT innovaTIONS



For more than 30 years, KS-Licht has continuously offered you new and innovative products and luminaire ranges on the subject of light. Here we present our new KS luminaire range **LIGHT Impressions 2024**.

### PICK-UP CENTRE IN ESSEN

We maintain a pick-up centre for LIGHT Impressions products in the heart of the Ruhr area, where you can collect the goods ordered from us at short notice.

### EXPERIENCE LUMAIRES LIVE

On more than 300 m<sup>2</sup> of exhibition space, we present a large selection of luminaires from all renowned manufacturers. Here, our professionally trained consultants and lighting designers will advise you personally. At the same time, you can use our exhibition to present our luminaires to your customers in terms of function and effect. Convince yourself of the quality of our outdoor luminaires in the outdoor exhibition.

### FREE LIGHTING DESIGN

We develop practical lighting solutions with you and according to your needs. Whether for business premises, salesrooms or private ambience: our lighting designers always have the right concepts for a demand-oriented and energetically sensible solution. We will be happy to calculate the payback time of your new, energy-saving LED lighting for you.

### KS MULTI-BRAND LUMAIRES ONLINE SHOP

In our business online shop at [www.KS-Light.co.uk](http://www.KS-Light.co.uk) you will find everything that supports you in your daily work:

- Current special offers and new products
- Online check of product availability
- Find and order all spare parts easily
- Quick order form
- All catalogues for downloading or as a flip catalogue with product links
- Tender texts, light distribution curves/LDT plug-ins and Quick calculation tables

**KS Licht- u. Elektrotechnik GmbH**  
**Manderscheidtstr. 8c**  
**45141 Essen**

Tel.: +49 (0)201-89924 - 0  
Fax: +49 (0)201-89924 - 124

Onlineshop: [www.KS-Light.co.uk](http://www.KS-Light.co.uk)  
Internet: [www.KS-Germany.com](http://www.KS-Germany.com)  
Email: [Sales@KS-Germany.com](mailto:Sales@KS-Germany.com)

**Visit us on site in Essen or give us a call:**

Monday - Thursday continuously from 08.00 hrs to 16.30 hrs  
Friday continuously from 08.00 hrs to 15.00 hrs

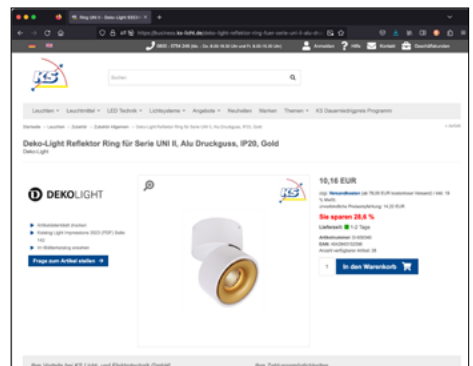

Scan the link to our quick order form and get up-to-date information about the availability of goods!



[www.ks-light.co.uk/quick-order-form](http://www.ks-light.co.uk/quick-order-form)

02 highlight buttons | overview

## **INTERIOR LIGHTS**

04 pendant lights  
10 surface mounted ceiling lights  
16 built in ceiling lights  
24 insert panels | sidelight technology  
26 office lights  
34 hall floodlight  
38 damp-proof luminaires

## **POWER RAILS**

40 D ONE 1-phase power rail system  
48 1-phase power rail luminaires  
54 3-phase power rail luminaires

## **BATTERY AND SOLAR LIGHTS**

60 battery lights

## **OUTDOOR LIGHTS**

64 bollard lights  
68 energy distributor  
70 ground recessed lights

## **PLANO**

72 PLANO luminaire system  
88 PLANO-profiles

## **LED STRIPES**

94 COB sauna | 1CH | 24V  
96 standard | 1CH | 48V  
98 standard | 3CH | 48V

## **POWER SUPPLIES**

100 DC | CV  
103 DC | CC

## **CONTROLLER**

104 RF-smart  
116 DMX dimmer  
117 DALI PWM dimmer

118 legend

## EVERYTHING IN VIEW

With our new highlight buttons, you can see at a glance which functions and highlights a luminaire offers. Here you will find all buttons at a glance.



### LIGHT COLOURS / CHANNELS

Depending on the LED equipment, different colours can be mixed with the luminaire via the individual RGB channels. Luminaires with RGBW equipment also contain single-colour white LEDs in the light colours warm white [WW], cool white [CW] or neutral white [NW].



### HCL

HCL stands for "Human Centric Lighting" and means the tuning of artificial light indoors to natural daylight and the human biorhythm. HCL-capable luminaires can be integrated into an HCL control system and their light colour can be adjusted.



### LIGHT COLOUR SELECTABLE

Luminaires with the designation "CCT Dip" can be changed in light colour via a dip switch on the housing and can thus be used particularly flexibly. The range usually extends from warm white [3,000K] to neutral white [4,000K] to cool white [5,000K].



### DIM TO WARM

The dim-to-warm function automatically adjusts the light colour when a luminaire is dimmed. The rule is: the lower the luminous intensity, the warmer the light colour. In this way, luminaires with dim-to-warm technology flexibly adapt to the mood of the room.



### BEG ELIGIBLE

Eligible luminaires under the BEG programme [Federal funding for efficient buildings] have a system luminous efficacy of at least 120 lm/W [140 lm/W for LED strips] and a service life of 50,000 hours at L80 [80 % luminosity].



### SUITABLE FOR VDU WORKSTATIONS

These luminaires meet the requirements of DIN standard EN 12464-1 according to the lighting of indoor workplaces. With a luminance value of  $L_{65} < 3000 \text{ cd/m}^2$ , the luminaires are standard-compliant for glare-free VDU workstations.



### PASSABLE

Drive-on recessed luminaires are generally used outdoors and can withstand particularly high pressure loads from pedestrians, vehicles and other objects. Drive-in luminaires have an IP protection of at least IP67.



### FSC CERTIFIED

FSC® ["Forest Stewardship Council®"] is an international certification system. Luminaires with FSC® certification use only wood from sustainable forestry and can demonstrate a sustainable value chain in this respect.



### THROUGH-WIRING POSSIBLE

This luminaire enables through-wiring and can be connected in series with other luminaires. The advantage: luminaires with through-wiring require only one power connection, eliminating the need for costly laying of additional cables.





### CONTROLLABLE VIA ...

The luminaire can be controlled via one of the following lighting control systems: RF smart [the new control system from DEKO-LIGHT for up to eight light zones], zigbee, DALI, RF [Radio Frequency], Bluetooth, WiFi.



### IP PROTECTION

The IP protection class indicates the protection of live parts against the ingress of foreign bodies and contact [first digit] and against water [second digit] with two digits. The following applies: The higher the respective digit, the higher the protection.



### UGR

The UGR value indicates how glare-free a luminaire is, thus avoiding disturbing reflections. The lower the UGR value, the more glare-free a luminaire emits its light. Luminaires with a UGR value < 19 are suitable for office environments and workplaces.



### IK IMPACT RESISTANCE

The IK value [or IK impact resistance level] indicates how shock and impact resistant a luminaire or certain components of the luminaire are. The following applies: The higher the IK value [IK00 to IK10+], the greater the protection against external mechanical stress.



### COLOUR RENDERING INDEX RA

The colour rendering index Ra describes the measure of the correspondence of the perceived light colour between an existing lighting situation and a reference light source. The higher the Ra value, the better/natural the colour rendering.



### COLOUR CONSISTENCY SDCM

The SDCM value describes the standard deviation of an LED from the target colour location and is a measure of production-related colour differences between LEDs with identical values. The higher the value, the greater the colour deviation. The maximum valid deviation is 6 SDCM.



### POWER SWITCH

Luminaires with an integrated power switch can be switched in wattage and operated in several power levels. The power reduction enables flexible adjustment of the light intensity and is usually carried out via a dip switch on the unit.



### TOOL-FREE INSTALLATION

These luminaires are delivered with pre-assembled components and can be mounted without additional tools. This saves time during installation and enables particularly simple and efficient conversion in the event of renovation or refurbishment.



## SLIM

The luminaires of the SLIM series include single-flame, three-flame pendant luminaires and matching pendant luminaires for the DEKO-LIGHT track light system. The luminaire body made of die-cast aluminium is always the same size [300 x 39mm]. With this, several SLIM models can be combined with each other in larger rooms. The pendant luminaires for ceiling installation with a maximum suspension of 180 cm are available as single- and three-lamp versions, the three-lamp version with either an elongated or round base, depending on the arrangement of the luminaires.

While the fixed SLIM models immerse dining tables, reading corners and more in a pleasant warm white light, the single-lamp SLIM track luminaire is particularly suitable for restaurant and retail projects with changing room layouts. A flexible textile cable underlines the quality of the SLIM series.



## SLIM RUND

- particularly soft textile cable
- glare-free thanks to low UGR value [ $<19$ ]
- slim design with a diameter of only 39 mm
- aluminium diecast
- dimensions H x  $\varnothing$ : 300 x 39 mm
- socket H x  $\varnothing$ : 25 x 100 mm
- max. suspension: 1800 mm
- incl. silver-coloured reflector ring

item	colour	colour temperature	light current	control	price
<b>342238</b>	<input type="checkbox"/> white	2700 K	500 lm	dimmmable	<b>84,95 €</b> <b>NEW</b>
<b>342237</b>	<input checked="" type="checkbox"/> black	2700 K	500 lm	dimmmable	<b>84,95 €</b> <b>NEW</b>
<b>342214</b>	<input type="checkbox"/> white	3000 K	500 lm		<b>79,95 €</b>
<b>342213</b>	<input checked="" type="checkbox"/> black	3000 K	500 lm		<b>79,95 €</b>

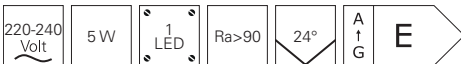

### accessories

<b>930747</b>	lens 15°	<b>4,95 €</b>
<b>930748</b>	lens 36°	<b>4,95 €</b>
<b>930749</b>	lens 60°	<b>4,95 €</b>
<b>930744</b>	reflector ring white	<b>4,95 €</b>
<b>930745</b>	reflector ring black	<b>4,95 €</b>
<b>930746</b>	reflector ring gold	<b>5,95 €</b>



## SLIM ROUND

- particularly soft textile cable
- glare-free thanks to low UGR value [ $<19$ ]
- slim design with a diameter of only 39 mm
- aluminium diecast
- dimensions H x  $\varnothing$ : 300 x 39 mm
- socket H x  $\varnothing$ : 240 x 25 mm
- max. suspension: 1800 mm
- incl. silver-coloured reflector ring

item	colour	colour temperature	light current	control	price
<b>342242</b>	white	2700 K	3x 500 lm	dimmbable	<b>209,95 €</b> <b>NEW</b>
<b>342241</b>	black	2700 K	3x 500 lm	dimmbable	<b>209,95 €</b> <b>NEW</b>
<b>342218</b>	white	3000 K	3x 500 lm		<b>199,95 €</b>
<b>342217</b>	black	3000 K	3x 500 lm		<b>199,95 €</b>

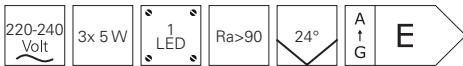

### accessories

<b>930747</b>	lens 15°	<b>4,95 €</b>
<b>930748</b>	lens 36°	<b>4,95 €</b>
<b>930749</b>	lens 60°	<b>4,95 €</b>
<b>930744</b>	reflector ring white	<b>4,95 €</b>
<b>930745</b>	reflector ring black	<b>4,95 €</b>
<b>930746</b>	reflector ring gold	<b>5,95 €</b>





## SLIM EDGED

- particularly soft textile cable
- glare-free thanks to low UGR value [ $<19$ ]
- slim design with a diameter of only 39 mm
- aluminium diecast
- dimensions H x  $\varnothing$ : 300 x 39 mm
- socket L x B x H: 370 x 80 x 26 mm
- max. suspension: 1800 mm
- incl. silver-coloured reflector ring

item	colour	colour temperature	light current	control	price
<b>342240</b>	<input type="checkbox"/> white	2700 K	3x 500 lm	dimnable	<b>209,95 €</b> <b>NEW</b>
<b>342239</b>	<input checked="" type="checkbox"/> black	2700 K	3x 500 lm	dimnable	<b>209,95 €</b> <b>NEW</b>
<b>342216</b>	<input type="checkbox"/> white	3000 K	3x 500 lm		<b>199,95 €</b>
<b>342215</b>	<input checked="" type="checkbox"/> black	3000 K	3x 500 lm		<b>199,95 €</b>

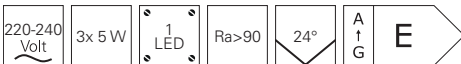

### accessories

<b>930747</b>	lens 15°	<b>4,95 €</b>
<b>930748</b>	lens 36°	<b>4,95 €</b>
<b>930749</b>	lens 60°	<b>4,95 €</b>
<b>930744</b>	reflector ring white	<b>4,95 €</b>
<b>930745</b>	reflector ring black	<b>4,95 €</b>
<b>930746</b>	reflector ring gold	<b>5,95 €</b>

## MADERA

The MADERA pendant luminaire combines modern design with environmental-friendly manufacturing. Each luminaire is made of high-quality European oak wood with FSC certification, sourced from sustainable forestry. With its touch sensor on the side, you can dim the brightness of the lamp to your liking and thus create a pleasant atmosphere. Choose between versions with indirect upward lighting for a soft ambience or select the practical height-adjustable option with a cable pull to adjust the luminaire perfectly at any time. To help protect our environment, the MADERA pendant luminaires are packaged environmentally friendly.



height adjustable



uplight and touch sensor



## MADERA

- modern design, exclusively at DEKO-LIGHT
- manufactured in Europe from high-quality, oiled oak wood of grade A
- FSC-certified raw material oak wood from sustainable forests
- environmental friendly packaging
- continuously dimmable via touch sensor
- height adjustable via cable pull
- incl. uplight [only 342235, 342236]
- oak wood | iron
- socket L x W x H: 370 x 50 x 30 mm
- max. suspension: 1000 mm

item	colour	colour temperature	light current	dimensions L x W x H	power	price
342234	brown, black	3000 K	1600 lm	900 x 42 x 60 mm	13 W	<b>549,95 €</b>
342235	brown, black	3000 K	2890 lm	1200 x 42 x 60 mm	22 W	<b>699,95 €</b>
342236	brown, black	3000 K	4400 lm	1600 x 42 x 60 mm	33 W	<b>799,95 €</b>







## LUCEA

The ceiling luminaires of the LUCEA series are available in the versions 6, 10, 15, 20 and 30 watts. They offer up to 2,900 lumens of light output, depending on the version. Through lenses, which are available as an option, the beam angle can be narrowed or widened.

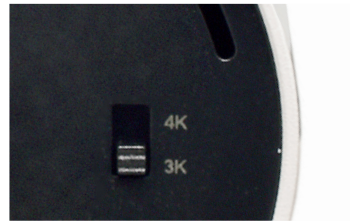





## LUCEA 6 + 10

- high colour rendering
- light colour adjustable in two steps [only 348153 and 348154]
- dimmable
- aluminium diecast
- dimensions H x Ø: 157 x 65 mm
- dimmable via phase control or phase cut-off
- light colour adjustable via dip switch
- incl. black reflector ring

item	colour	colour temperature	light current	power	price
<b>348213</b>	<input type="checkbox"/> white	2700 K	600 lm	6 W	<b>129,95 €</b> <b>NEW</b>
<b>348214</b>	<input checked="" type="checkbox"/> black	2700 K	600 lm	6 W	<b>129,95 €</b> <b>NEW</b>
<b>348215</b>	<input type="checkbox"/> white	2700 K	1000 lm	10 W	<b>119,95 €</b> <b>NEW</b>
<b>348216</b>	<input checked="" type="checkbox"/> black	2700 K	1000 lm	10 W	<b>119,95 €</b> <b>NEW</b>
<b>348153</b>	<input type="checkbox"/> white	3000 / 4000 K	930 / 1000 lm	10 W	<b>119,95 €</b>
<b>348154</b>	<input checked="" type="checkbox"/> black	3000 / 4000 K	930 / 1000 lm	10 W	<b>119,95 €</b>



### accessories

<b>930679</b>	lens 24°	<b>9,95 €</b>
<b>930756</b>	Reflector ring white	<b>4,95 €</b>
<b>930757</b>	Reflector ring black	<b>4,95 €</b>
<b>930758</b>	Reflector ring gold	<b>4,95 €</b>



## LUCEA

The rotating and swivelling ceiling luminaires of the LUCEA series are available in wattages of 6, 10, 15, 20 and 30 watts. With a rotation angle of 350° and a swivel angle of 90°, the luminaires can be individually adjusted to customer requirements. Depending on the version, they offer up to 2,900 lumens of light output. The beam angle can be narrowed or widened by exchanging optionally available lenses.





## LUCEA TILT 6 + 10

- high colour rendering
- light colour adjustable in two steps [only 348161 and 348162]
- dimmable
- aluminium diecast
- dimensions H x Ø: 218 x 65 mm
- socket H x Ø: 29 x 104,5 mm
- dimmable via phase control or phase cut-off
- incl. black reflector ring

item	colour	colour temperature	light current	power	price
348223	<input type="checkbox"/> white	2700 K	600 lm	6 W	<b>129,95 €</b> <b>NEW</b>
348224	<input checked="" type="checkbox"/> black	2700 K	600 lm	6 W	<b>129,95 €</b> <b>NEW</b>
348225	<input type="checkbox"/> white	2700 K	1000 lm	10 W	<b>119,95 €</b> <b>NEW</b>
348226	<input checked="" type="checkbox"/> black	2700 K	1000 lm	10 W	<b>119,95 €</b> <b>NEW</b>
348161	<input type="checkbox"/> white	3000 / 4000 K	930 / 1000 lm	10 W	<b>129,95 €</b>
348162	<input checked="" type="checkbox"/> black	3000 / 4000 K	930 / 1000 lm	10 W	<b>129,95 €</b>



### accessories

<b>930679</b>	lens 24° for LUCEA 6/10	<b>9,95 €</b>
<b>930752</b>	barn door for LUCEA 6/10 white	<b>22,95 €</b>
<b>930753</b>	barn door for LUCEA 6/10 black	<b>22,95 €</b>
<b>930756</b>	reflector ring for LUCEA 6/10 white	<b>4,95 €</b>
<b>930757</b>	reflector ring for LUCEA 6/10 black	<b>4,95 €</b>
<b>930758</b>	reflector ring for LUCEA 6/10 gold	<b>4,95 €</b>



## MADERA

The MADERA series is made of first-class European oak wood and impresses with its modern design and mix of materials in private living areas, hotels, restaurants and many more. The noble MADERA luminaires distribute their powerful warm white light in any room and thus also cut an excellent figure as functional and high-quality lighting at reception counters and more.







uplight



## MADERA

- modern design
- Made in Europe from high-quality grade A oak wood
- FSC-certified raw material oak wood from sustainable forests
- environmental friendly packaging
- incl. uplight [only 348212]
- oak wood | iron
- socket L x B x H: 250 x 135 x 30 mm

item	colour	colour temperature	light current	dimensions L x W x H	power	control	EEI	price
348147	brown, black	3000 K	1120 lm	810 x 135 x 115 mm	15 W		F	<b>489,95 €</b>
348212	brown, black	3000 K	2740 lm	1100 x 42 x 60 mm	22 W	dimmmable	D	<b>549,95 €</b>

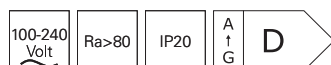

## DIONE

The new DIONE series comprises elegant recessed spotlights in aluminium housing with particularly shallow mounting depth - a real problem solver in the refurbishment sector.

The popular DIONE recessed ceiling luminaires with high-quality COB LED including reflector are housed in an aluminium casing and have a cut-out dimension of 68 mm. While the available colours white, silver, black, chrome and nickel harmonise with almost any type of ceiling, the actual special feature of the DIONE is not visible when installed: The recessed spotlights are extremely space-saving when installed and require only 25 or 27 mm of ceiling cavity. This is where the power supply unit and the Quick connection box are located, which allows 3-pole through-wiring of several DIONE models as well as retrofitting as part of renovations.

The plug-in connector between the spotlight and the power supply unit allows installers to conveniently install the lighting equipment and connect the spotlight once the ceiling work has been completed.

The DIONE recessed spotlights are available in the light colours 2,700K, 3,000 K, 4,000 K and as a dim-to-warm version [1,800- 3,000K]. In addition to the IP20 version, an IP44 version is also available, making the DIONE suitable for bathrooms and other damp areas indoors.

With this variety, the DIONE series offers recessed spotlights for a wide range of applications - from private homes and exhibition areas to guest areas in hotels and restaurants. Thanks to the wide selection of light colours and IP classes, the DIONE can be flexibly integrated into any environment and covers all design requirements, from a feel-good character to functional lighting.



only 25 or 27 mm ceiling cavity required

HxØ: 41 x 82 mm [cut-out dimension 68 mm]

aluminium housing in white, silver, black, chrome and brushed nickel

reflector with 36° beam angle

high-quality COB technology with up to 800 lm

new connector between spot and power supply unit for even more convenient mounting

dimnable power supply unit

Quick connection box with quick-release fastener [optionally fixable with screw] for quick installation and through-wiring for flexible and rigid cables up to 1.5 mm<sup>2</sup> NYM

## THAT'S HOW EASY IT IS



1 - Quick wiring / through-wiring on the Quick connection box due to screwless plug-in terminals



2 - quick connection box is placed over the 68 mm cut-out in the cavity



3 - compact power supply unit is inserted into the cavity



4 - connect the power supply unit to the spot using the connector



5 - inserting the spot into the ceiling cut-out



6 - The result: a compact installation with a swivelling spot, a dimmable power supply unit and the option of through-wiring in the ceiling cavity - ideal in refurbishment areas.

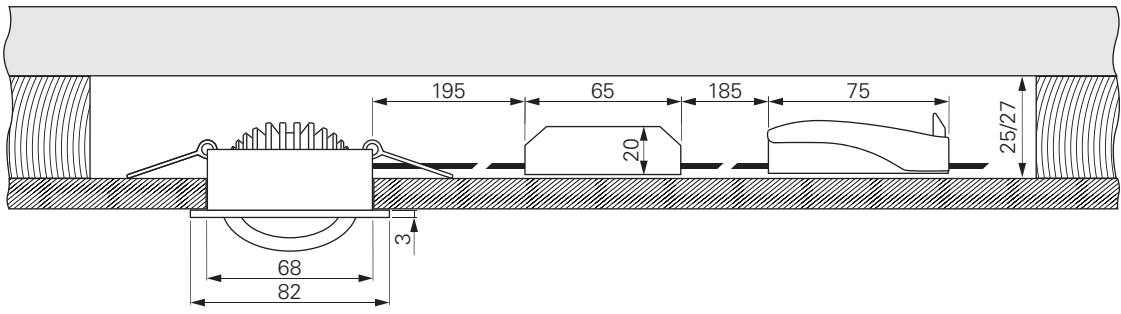





## DIONE IP20

- aluminium
- dimensions H x Ø: 41 x 82 mm
- through-wiring also possible with NYM 3x 1.5 m<sup>2</sup>
- quick installation through Quick-Terminal
- dimmable via phase cut-off [C-suitable/compatible]

Quick-Terminal  
with possibility for  
through-wiring

item	colour	colour temperature	light current	required ceiling cavity [min.]	EEL	price
565375	white	2700 K	750 lm	25 mm	E	59,95 € <b>NEW</b>
565376	silver coloured	2700 K	750 lm	25 mm	E	59,95 € <b>NEW</b>
565377	black	2700 K	750 lm	25 mm	E	59,95 € <b>NEW</b>
565379	chrome	2700 K	750 lm	25 mm	E	59,95 € <b>NEW</b>
565378	nickel brushed	2700 K	750 lm	25 mm	E	59,95 € <b>NEW</b>
565355	white	3000 K	800 lm	25 mm	E	59,95 €
565356	silver coloured	3000 K	800 lm	25 mm	E	59,95 €
565357	black	3000 K	800 lm	25 mm	E	59,95 €
565372	chrome	3000 K	800 lm	25 mm	E	59,95 € <b>NEW</b>
565371	nickel brushed	3000 K	800 lm	25 mm	E	59,95 € <b>NEW</b>
565358	white	4000 K	800 lm	25 mm	E	59,95 €
565359	silver coloured	4000 K	800 lm	25 mm	E	59,95 €
565360	black	4000 K	800 lm	25 mm	E	59,95 €
565374	chrome	4000 K	800 lm	25 mm	E	59,95 € <b>NEW</b>
565373	nickel brushed	4000 K	800 lm	25 mm	E	59,95 € <b>NEW</b>
565380	white	1800-3000 K	480 lm	25 mm	F	69,95 € <b>NEW</b>
565381	silver coloured	1800-3000 K	480 lm	25 mm	F	69,95 € <b>NEW</b>
565382	black	1800-3000 K	480 lm	25 mm	F	69,95 € <b>NEW</b>
565383	chrome	1800-3000 K	480 lm	25 mm	F	69,95 € <b>NEW</b>
565384	nickel brushed	1800-3000 K	480 lm	25 mm	F	69,95 € <b>NEW</b>



accessories when using insulating material [creates the necessary distance]

829063

safety spacer

5,95 €



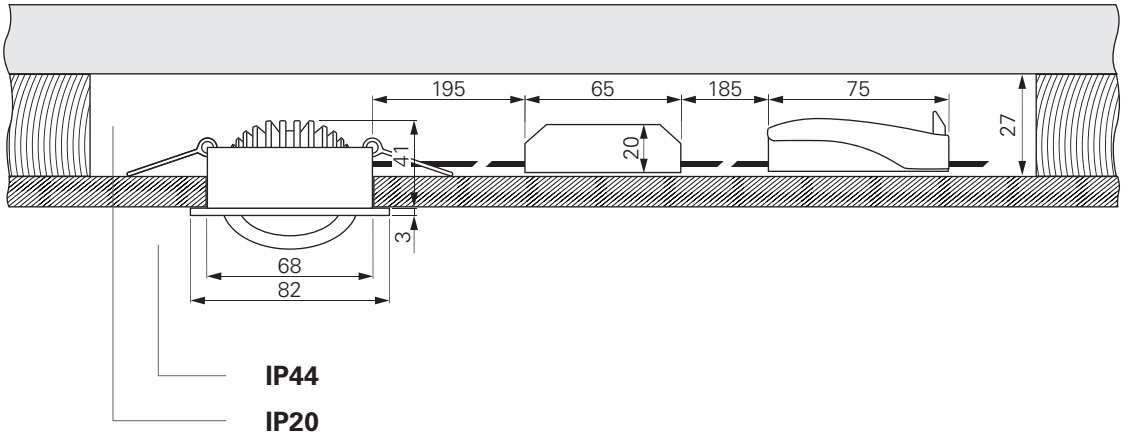



Quick-Terminal  
with possibility for  
through-wiring

## DIONE IP44/IP20

- aluminium
- dimensions H x Ø: 41 x 82 mm
- through-wiring also possible with NYM 3x 1.5 m<sup>2</sup>
- quick installation through Quick-Terminal
- dimmable via phase cut-off [C-suitable/compatible]

item	colour	colour temperature	light current	required ceiling cavity [min.]	EEL	price
565388	<input type="checkbox"/> white	2700 K	750 lm	27 mm	E	64,95 €
565389	<input type="checkbox"/> silver coloured	2700 K	750 lm	27 mm	E	64,95 €
565390	<input type="checkbox"/> black	2700 K	750 lm	27 mm	E	64,95 €
565391	<input type="checkbox"/> chrome	2700 K	750 lm	27 mm	E	64,95 €
565392	<input type="checkbox"/> nickel brushed	2700 K	750 lm	27 mm	E	64,95 €
565393	<input type="checkbox"/> white	3000 K	800 lm	27 mm	E	64,95 €
565394	<input type="checkbox"/> silver coloured	3000 K	800 lm	27 mm	E	64,95 €
565395	<input type="checkbox"/> black	3000 K	800 lm	27 mm	E	64,95 €
565396	<input type="checkbox"/> chrome	3000 K	800 lm	27 mm	E	64,95 €
565397	<input type="checkbox"/> nickel brushed	3000 K	800 lm	27 mm	E	64,95 €
565398	<input type="checkbox"/> white	4000 K	800 lm	27 mm	E	64,95 €
565399	<input type="checkbox"/> silver coloured	4000 K	800 lm	27 mm	E	64,95 €
565400	<input type="checkbox"/> black	4000 K	800 lm	27 mm	E	64,95 €
565401	<input type="checkbox"/> chrome	4000 K	800 lm	27 mm	E	64,95 €
565402	<input type="checkbox"/> nickel brushed	4000 K	800 lm	27 mm	E	64,95 €
565403	<input type="checkbox"/> white	1800-3000 K	480 lm	27 mm	F	74,95 €
565404	<input type="checkbox"/> silver coloured	1800-3000 K	480 lm	27 mm	F	74,95 €
565405	<input type="checkbox"/> black	1800-3000 K	480 lm	27 mm	F	74,95 €
565406	<input type="checkbox"/> chrome	1800-3000 K	480 lm	27 mm	F	74,95 €
565407	<input type="checkbox"/> nickel brushed	1800-3000 K	480 lm	27 mm	F	74,95 €



accessories when using insulating material [creates the necessary distance]

**829063** safety spacer

**5,95 €**



## SMD-68-230V-RUND

A lot of power for a small price! The recessed luminaires of the SMD-68 series provide up to 550 lm and also have an integrated, dimmable power supply unit [230V direct connection], which makes the use of GU10 sockets and retrofit upgrades unnecessary.



## SMD-68-230V-ROUND

- plastic
- dimensions H x Ø: 44 x 85 mm
- dimmable via phase control or phase cut-off
- swivelling

item	colour	colour temperature	light current	EEl	price
<b>565337</b>	white	2700 K	510 lm	G	<b>19,95 €</b>
<b>565385</b>	black	2700 K	510 lm	G	<b>19,95 €</b> <b>NEW</b>
<b>565338</b>	white	3000 K	540 lm	F	<b>19,95 €</b>
<b>565386</b>	black	3000 K	540 lm	F	<b>19,95 €</b> <b>NEW</b>
<b>565339</b>	white	4000 K	550 lm	G	<b>19,95 €</b>
<b>565387</b>	black	4000 K	550 lm	G	<b>19,95 €</b> <b>NEW</b>









dip switch



NEW

## LED PANEL STANDARD FLEX

- aluminium
- UGR<22
- light colour adjustable via dip switch

item	colour	colour temperature	light current	dimensions L x B x H	Strom	power EEI	price
<b>100123</b>	<input type="checkbox"/>	white    3000/4000/6000 K	3780/4200/4000 lm	620 x 620 x 9 mm	1050 mA	42 W G	<b>119,95 €</b>
<b>100125</b>	<input type="checkbox"/>	white    3000/4000/6000 K	3570/3990/3780 lm	1195 x 295 x 9 mm	1050 mA	42 W E	<b>124,95 €</b>
<b>100139</b>	<input type="checkbox"/>	white    3000/4000/6000 K	5300/6000/5700 lm	1195 x 595 x 9 mm	1500 mA	60 W D	<b>219,95 €</b>
<b>100154</b>	<input type="checkbox"/>	white    3000/4000/6000 K	5300/6000/5700 lm	1240 x 620 x 9 mm	1500 mA	60 W D	<b>229,95 €</b>

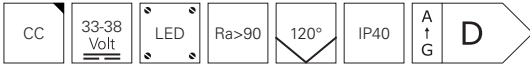

### accessories

**930674** safety rope **4,95 €**

### accessories for **100123**

**930672** wire suspension | 200 cm **22,95 €**  
**930665** surface mounting frame | 62,5 x 62,5 x 7 cm **59,95 €**  
**930670** mounting frame | 62,5 x 62,5 cm **59,95 €**  
**862258** power supply QUICK dimmable | 1050mAh | 22-43V | 23,1-45,0 W quick installation through Quick-Terminal und through-wiring **46,95 €**  
**862193** power supply MULTI-CC DALI1/2/Intelli-Push dimmable | 14-43V | 14,7-45,0 W **69,95 €**

### accessories for **100125**

**930672** wire suspension | 200 cm **22,95 €**  
**930666** surface mounting frame | 120 x 30 x 7 cm **69,95 €**  
**930671** mounting frame | 120 x 30 cm **69,95 €**  
**862258** power supply QUICK dimmable | 1050mAh | 22-43V | 23,1-45,0 W quick installation through Quick-Terminal und through-wiring **46,95 €**  
**862193** power supply MULTI-CC DALI1/2/Intelli-Push dimmable | 14-43V | 14,7-45,0 W **69,95 €**

### accessories for **100139**

**930673** wire suspension | 200 cm **32,95 €**  
**930675** surface mounting frame | 120 x 60 x 7 cm **69,95 €**  
**930688** mounting frame | 120 x 60 cm **84,95 €**  
**862259** power supply QUICK dimmable | 1500mAh | 20-40V | 30,0-60,0 W quick installation through Quick-Terminal und through-wiring **56,95 €**  
**862194** power supply MULTI-CC DALI1/2/Intelli-Push dimmable | 25-70V | 26,3-75,0 W **84,95 €**

### accessories for **100154**

**930673** wire suspension | 200 cm **32,95 €**  
**862259** power supply QUICK dimmable | 1500mAh | 20-40V | 30,0-60,0 W quick installation through Quick-Terminal und through-wiring **56,95 €**  
**862194** power supply MULTI-CC DALI1/2/Intelli-Push dimmable | 25-70V | 26,3-75,0 W **84,95 €**



## LED PANEL STANDARD RGBW

- aluminium
- particularly powerful and intense colours
- dimmable via optional controller

item	colour	colour temperature	light current	dimensions L x W x H	power RGB	power W	price
<b>100152</b>	<input type="checkbox"/> white	RGB + 3000 K	4000 lm	620 x 620 x 11 mm	3x 18W	40W	<b>189,95 €</b>
<b>100153</b>	<input type="checkbox"/> white	RGB + 4000 K	4200 lm	620 x 620 x 11 mm	3x 18W	40W	<b>189,95 €</b>
<b>100156</b>	<input type="checkbox"/> white	RGB + 3000 K	4000 lm	595 x 595 x 11 mm	3x 18W	40W	<b>184,95 € NEW</b>
<b>100157</b>	<input type="checkbox"/> white	RGB + 4000 K	4200 lm	595 x 595 x 11 mm	3x 18W	40W	<b>184,95 € NEW</b>

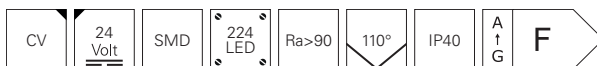

### accessories

<b>862166</b>	power supply   24V DC   100 W   IP20	<b>96,95 €</b>
<b>872091</b>	power supply   24V DC   320 W   IP67	<b>219,95 €</b>
<b>843502</b>	RF-smart controller starter set RGBW   12/24/48V	<b>99,95 €</b>
<b>843037</b>	Casambi Bluetooth dimmer 4 Channel   12/24V	<b>179,95 €</b>
<b>843010</b>	DALI DT6 DMX PWM dimmer 4 channel   12/24/48V  12/24V	<b>129,95 €</b>
<b>843070</b>	DALI1/2 DT6 dimmer 4 channel   12/24/48V	<b>134,95 €</b>
<b>843279</b>	DMX PWM dimmer 4 channel   12/24/48V	<b>114,95 €</b>

### accessories for **100152/10153**

<b>930665</b>	surface mounting frame   62,5 x 62,5 x 7 cm	<b>59,95 €</b>
<b>930668</b>	mounting frame   62,5 x 62,5 cm	<b>57,95 €</b>

### accessories for **100156/10157**

<b>930664</b>	surface mounting frame   60 x 60 x 7 cm	<b>54,95 €</b>
<b>930667</b>	mounting frame   60 x 60 cm	<b>52,95 €</b>

## RADAR PRESENCE DETECTOR

- the luminaire switches on automatically at the slightest movement
- without movement, the brightness is reduced to 30% after 5/15/30 minutes [time adjustable]
- without movement, the luminaire switches off after further 5/15/30 minutes

## DAYLIGHT SENSOR

- switch on the luminaire and dim it to the desired brightness [this setting is saved as a default by the daylight sensor]
- if the ambient light changes, the sensor adjusts the brightness to the stored standard [10% tolerance]

## UNIVERSAL TABLE CLAMP

- The table clamp can be used for table tops with a total thickness of 15-65 mm [incl. substructure] as required.
- If part of the frame construction is located within the clamping area of the luminaire, the supplied hard rubber buffers should be used to compensate for the unevenness and to create a surface-flush clamping area.
- Due to the design of the table clamp, mounting on almost all table tops is possible.

## OPTIONAL MOUNTING KIT

- For larger table tops, or if positioning on the table is desired, the optional mounting kit can be used instead of the pre-installed table clamp. This is simply mounted through a drill hole in the table.
- suitable for table tops of 15-35 mm total thickness
- suitable for hole diameters of 22-30 mm mounting kit

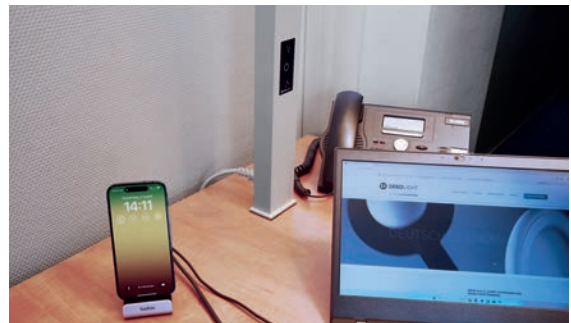
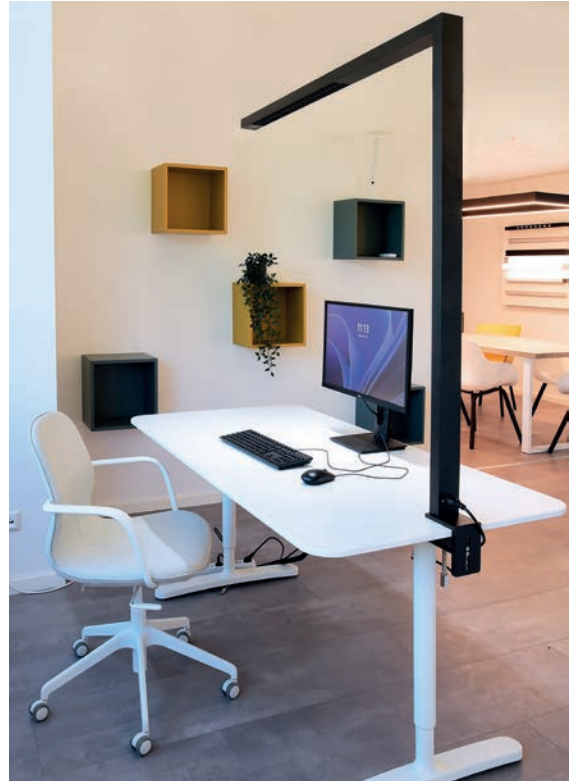





## OFFICE THREE STANDARD TABLE

- UGR<6
- SDCM <3
- Lifetime 50.000h L80B10
- BEG eligible
- suitable for VDU workstations according to EN 12464-1 BAP65 [L65 <= 3000cd/m²]
- optimal for high-quality illumination of height-adjustable individual workstations
- newly designed and extended luminaire head for ideal illumination of 160x80cm tables
- aluminium
- dimensions L x W x H: 1159 x 64 x 1194 mm
- base L x W: 500 x 225 mm
- gap size base: 100 mm
- suitable for table constructions with 15-65 mm thickness
- CRI>95 for direct light
- direct and indirect light separately via touch panel dimmable and switchable
- high-precision radar presence detector detects the slightest movements
- sensor run-on time adjustable [5 / 15 / 30 min]
- daylight sensor for dynamic brightness adjustment
- incl. 2.5 m connection cable with shock-proof plug and cold appliance plug C21
- incl. hard rubber buffers for underlaying table constructions running close to the edge



sensor



touch dimmer



table clamp

item	colour	colour temperature	luminous flux	price
346063	white	4000 K	10100 lm	999,95 €
346064	silver coloured	4000 K	10100 lm	999,95 €
346065	black	4000 K	10100 lm	999,95 €



### accessories

930727	mounting kit for drill hole white	39,95 €
930728	mounting kit for drill hole aluminium	39,95 €
930729	mounting kit for drill hole black	39,95 €



## RADAR PRESENCE DETECTOR

- the luminaire switches on automatically at the slightest movement
- without movement, the brightness is reduced to 30% after 5/15/30 minutes [time adjustable]
- without movement, the luminaire switches off after further 5/15/30 minutes

## DAYLIGHT SENSOR

- switch on the luminaire and dim it to the desired brightness [this setting is saved as a default by the daylight sensor]
- if the ambient light changes, the sensor adjusts the brightness to the stored standard [10% tolerance]

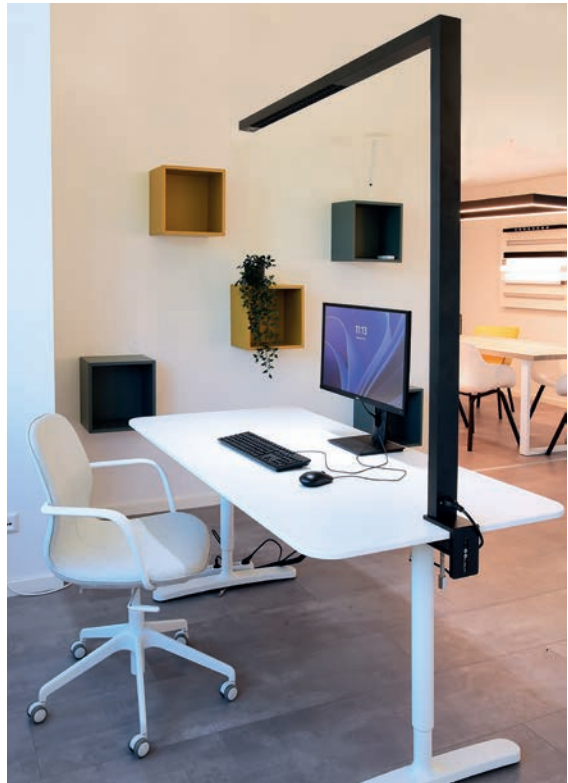

## UNIVERSAL TABLE CLAMP

- The table clamp can be used for table tops with a total thickness of 15-65 mm [incl. substructure] as required.
- If part of the frame construction is located within the clamping area of the luminaire, the supplied hard rubber buffers should be used to compensate for the unevenness and to create a surface-flush clamping area.
- Due to the design of the table clamp, mounting on almost all table tops is possible.



## OPTIONAL MOUNTING KIT

- For larger table tops, or if positioning on the table is desired, the optional mounting kit can be used instead of the pre-installed table clamp. This is simply mounted through a drill hole in the table.
- suitable for table tops of 15-35 mm total thickness
- suitable for hole diameters of 22-30 mm mounting kit

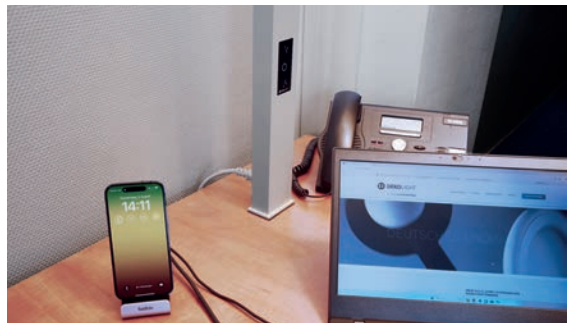

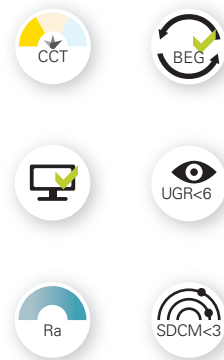

## OFFICE THREE PRO TABLE

- UGR<6
- SDCM <3
- Lifetime 50.000h L80B10
- BEG eligible
- suitable for VDU workstations according to EN 12464-1 BAP65 [L65 <= 3000cd/m²]
- optimal for high-quality illumination of height-adjustable individual workstations
- newly designed and extended luminaire head for ideal illumination of 160x80cm tables
- aluminium
- dimensions L x W x H: 1159 x 64 x 1194 mm
- base L x W: 500 x 225 mm
- gap size base: 100 mm
- suitable for table constructions with 15-65 mm thickness
- CRI>95 for direct light
- direct and indirect light separately via touch panel dimmable and switchable
- light colour adjustable via touch panel
- high-precision radar presence detector detects the slightest movements
- daylight sensor for dynamic brightness adjustment
- incl. 2.5 m connection cable with shock-proof plug and cold appliance plug C21
- incl. hard rubber buffers for underlaying table constructions running close to the edge



sensor



touch dimmer



table clamp

item	colour	colour temperature	luminous flux	price
346066	white	2700-6500 K	9800 lm	<b>1.199,95 €</b>
346067	silver coloured	2700-6500 K	9800 lm	<b>1.199,95 €</b>
346068	black	2700-6500 K	9800 lm	<b>1.199,95 €</b>



### accessories

930727	mounting kit for drill hole white	<b>39,95 €</b>
930728	mounting kit for drill hole aluminium	<b>39,95 €</b>
930729	mounting kit for drill hole black	<b>39,95 €</b>





With the kind support of Salvia Elektrotechnik GmbH

### **RADAR PRESENCE DETECTOR**

- the luminaire switches on automatically at the slightest movement
- without movement, the brightness is reduced to 30% after 5/15/30 minutes [time adjustable]
- without movement, the luminaire switches off after further 5/15/30 minutes

### **DAYLIGHT SENSOR**

- switch on the luminaire and dim it to the desired brightness [this setting is saved as a default by the daylight sensor]
- if the ambient light changes, the sensor adjusts the brightness to the stored standard [10% tolerance]



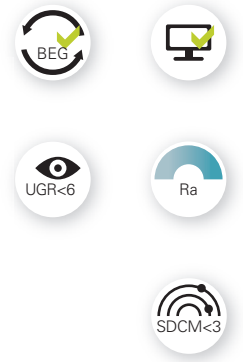

sensor



touch dimmer

## OFFICE THREE STANDARD FLOOR

- UGR<6
- SDCM <3
- Lifetime 50.000h L80B10
- BEG eligible
- suitable for VDU workstations according to EN 12464-1 BAP65 [L65 ≤ 3000cd/m²]
- optimal for high-quality illumination of individual workstations
- newly designed and extended luminaire head for ideal illumination of 160 x 80 cm tables
- aluminium
- dimensions L x W x H: 1240 x 64 x 1950 mm
- CRI>95 for direct light
- direct and indirect light separately via touch panel dimmable and switchable
- light colour adjustable via touch panel
- high-precision radar presence detector detects the slightest movements
- daylight sensor for dynamic brightness adjustment
- incl. 2.5 m connection cable with shock-proof plug and cold appliance plug C21

item	colour	colour temperature	luminous flux	price
342228	<input type="checkbox"/> white	<input type="checkbox"/> 4000 K	10100 lm	<b>1.199,95 €</b>
342229	<input type="checkbox"/> silver coloured	<input type="checkbox"/> 4000 K	10100 lm	<b>1.199,95 €</b>
342230	<input type="checkbox"/> black	<input type="checkbox"/> 4000 K	10100 lm	<b>1.199,95 €</b>





With the kind support of Salvia Elektrotechnik GmbH

## RADAR PRESENCE DETECTOR

- the luminaire switches on automatically at the slightest movement
- without movement, the brightness is reduced to 30% after 5/15/30 minutes [time adjustable]
- without movement, the luminaire switches off after further 5/15/30 minutes

## DAYLIGHT SENSOR

- switch on the luminaire and dim it to the desired brightness [this setting is saved as a default by the daylight sensor]
- if the ambient light changes, the sensor adjusts the brightness to the stored standard [10% tolerance]

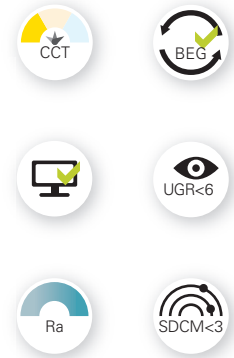

sensor



touch dimmer

## OFFICE THREE PRO FLOOR

- UGR<6
- SDCM <3
- Lifetime 50.000h L80B10
- BEG eligible
- suitable for VDU workstations according to EN 12464-1 BAP65 [L65 ≤ 3000cd/m²]
- optimal for high-quality illumination of individual workstations
- newly designed and extended luminaire head for ideal illumination of 160 x 80 cm tables
- aluminium
- dimensions L x W x H: 1240 x 64 x 1950 mm
- CRI>95 for direct light
- direct and indirect light separately via touch panel dimmable and switchable
- high-precision radar presence detector detects the slightest movements
- sensor run-on time adjustable [5 / 15 / 30 min]
- daylight sensor for dynamic brightness adjustment
- incl. 2.5 m connection cable with shock-proof plug and cold appliance plug C21

item	colour	colour temperature	luminous flux	price
342231	<input type="checkbox"/> white	ww cw 2700-6500 K	9800 lm	<b>1.399,95 €</b>
342232	<input type="checkbox"/> silver coloured	ww cw 2700-6500 K	9800 lm	<b>1.399,95 €</b>
342233	<input type="checkbox"/> black	ww cw 2700-6500 K	9800 lm	<b>1.399,95 €</b>



## VEGA

The VEGA high bay floodlight - quality that convinces. In industrial / storage halls or similar, the hall floodlight is the perfect solution when it comes to first-class lighting. In the version with three adjustable power levels, they adapt to your requirements. At the same time, the spotlights are particularly energy-efficient, which has a positive effect on your operating costs. With a long service life of 50,000 hours [L80B20], they provide long-lasting, reliable lighting without compromise. Thanks to optional lenses, VEGA spotlights can achieve a UGR value of less than 19 to ensure glare-free light. And for those who want precise lighting control, we offer variants with Dali control. In addition, the high-bay spotlights are BEG subsidy-eligible.



## VEGA

- high-quality, versatile and powerful hall downlight
- power adjustable in three stages
- particularly energy-efficient
- service life 50,000 h L80B20
- BEG eligible
- UGR<19 with optional lens
- aluminium diecast
- incl. 1.5 m connection cable

item	colour	colour temperature	light current	power	dimensions H x Ø	price
<b>732156</b>	■ black	nw 4000 K	15300 / 23400 / 28800 lm	90 / 130 / 160 W	120 x 400 mm	<b>319,95 €</b>
<b>732158</b>	■ black	cv 5700 K	15300 / 23400 / 28800 lm	90 / 130 / 160 W	120 x 400 mm	<b>319,95 €</b>



### accessories

<b>930743</b>	lens 60°	<b>49,95 €</b>
<b>930641</b>	suspension set 1m chain	<b>14,95 €</b>
<b>930685</b>	suspension set 3m chain	<b>24,95 €</b>
<b>930742</b>	wall mounting arm OnOff	<b>39,95 €</b>









## VEGA DALI

- high-quality, versatile and powerful hall downlight
- particularly energy-efficient
- service life 50,000 h L80B20
- BEG eligible
- UGR<19 with optional lens
- aluminium diecast
- incl. 1.5 m connection cable

item	colour	colour temperature	light current	power	control	dimensions H x Ø	price
732157	black	nw 4000 K	28800 lm	160 W	DALI 2 / DT6	122 x 400 mm	369,95 €
732159	black	cw 5700 K	28800 lm	160 W	DALI 2 / DT6	122 x 400 mm	369,95 €



### accessories

930743	lens 60°	49,95 €
930641	suspension set 1m chain	14,95 €
930685	suspension set 3m chain	24,95 €
930775	wall mounting arm DALI	39,95 €









With the kind support of WIBU-SYSTEMS AG Karlsruhe

## TRI PROOF BASIC

Discover our TRI PROOF BASIC damp-proof luminaire. The luminaires are BEG eligible and particularly energy-efficient - this means lower operating costs for your customers. With their robust construction and long service life, the luminaires are very durable. The pre-installed through-wiring and the practical cable entries on the back significantly simplify the installation. The metal clips ensure reliable locking. In addition, we offer variants with a motion detector where the brightness level, the detection range and the switch-off interval can be adjusted.

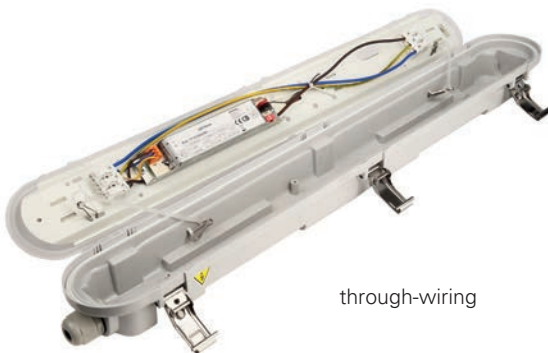

through-wiring



safe assembly  
thanks to safety rope



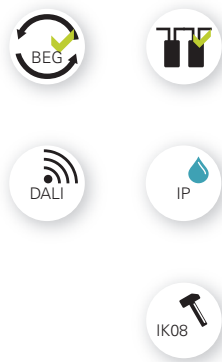

## TRI PROOF BASIC

- BEG eligible
- particularly energy-efficient
- long service life 50,000h L80B50
- through-wiring 3x1.5mm<sup>2</sup> / 5x1,5mm<sup>2</sup> [DALI] pre-installed
- cable entry at the rear
- stainless steel clamps on the cover can be locked with screws
- robust plastic housing made of polycarbonate [PC]

item	colour	colour temperature	light current	dimensions L x W x H	power	control	price
730483	grey	4000 K	2520 lm	610 x 82 x 75 mm	18 W		54,95 €
730486	grey	4000 K	5040 lm	1210 x 82 x 75 mm	36 W		79,95 €
730489	grey	4000 K	7700 lm	1510 x 82 x 75 mm	55 W		94,95 €
730485	grey	4000 K	2520 lm	610 x 82 x 75 mm	18 W	DALI 2 / DT6	104,95 €
730488	grey	4000 K	5040 lm	1210 x 82 x 75 mm	36 W	DALI 2 / DT6	129,95 €
730491	grey	4000 K	7700 lm	1510 x 82 x 75 mm	55 W	DALI 2 / DT6	159,95 €



accessories

930713 rope suspension 19,95 €



## TRI PROOF BASIC MOTION

- BEG eligible
- particularly energy-efficient
- long service life 50,000h L80B50
- through-wiring 3x1.5mm<sup>2</sup> pre-installed
- cable entry at the rear
- stainless steel clamps on the cover can be locked with screws
- robust plastic housing made of polycarbonate [PC]
- adjustable radar motion sensor

item	colour	colour temperature	light current	dimensions L x W x H	power	price
730484	grey	4000 K	2520 lm	610 x 82 x 75 mm	18 W	74,95 €
730487	grey	4000 K	5040 lm	1210 x 82 x 75 mm	36 W	99,95 €
730490	grey	4000 K	7700 lm	1510 x 82 x 75 mm	55 W	114,95 €



accessories

930713 rope suspension 19,95 €



## D LINE POWER RAIL SYSTEM 3-PHASE 230V

D ONE is the new 1-phase track system for 230V use and is now available exclusively at DEKO-LIGHT. The extremely compact and filigree system combines the advantages of 48V low-voltage tracks [slim design] with the practical benefits of established 230V systems [transformerless operation]. With their small dimensions, all D ONE components fit perfectly into a wide variety of interiors and give private living spaces and commercial interiors, such as shops and bars, a refined, discreet and timeless look.

All D ONE components are available in the universally suitable colours white and black and enable a wide variety of mounting options for flexible application use. Thanks to the new Flex feeder with ceiling canopy, the D ONE track system can be installed even if the power connection is not available in the immediate vicinity.



### D ONE MOUNTING POWER RAIL

- aluminium
- 1-phase

item	colour	dimensions W x H x L	price
<b>720000</b>	<input type="checkbox"/> white	26,2 x 22,2 x 1000 mm	<b>39,95 €</b>
<b>720001</b>	<input type="checkbox"/> white	26,2 x 22,2 x 2000 mm	<b>69,95 €</b>
<b>720002</b>	<input type="checkbox"/> white	26,2 x 22,2 x 3000 mm	<b>99,95 €</b>
<b>720003</b>	<input checked="" type="checkbox"/> black	26,2 x 22,2 x 1000 mm	<b>39,95 €</b>
<b>720004</b>	<input checked="" type="checkbox"/> black	26,2 x 22,2 x 2000 mm	<b>69,95 €</b>
<b>720005</b>	<input checked="" type="checkbox"/> black	26,2 x 22,2 x 3000 mm	<b>99,95 €</b>

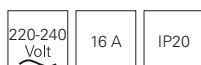



### D ONE ELECTRIC FEEDER LEFT

- plastic
- power feed possible from above [ceiling] or from the side

item	colour	dimensions L x W x H	price
<b>720006</b>	<input type="checkbox"/> white	71 x 26 x 22,2 mm	<b>13,95 €</b>
<b>720007</b>	<input checked="" type="checkbox"/> black	71 x 26 x 22,2 mm	<b>13,95 €</b>

220-240 Volt	16 A	IP20
-----------------	------	------



### D ONE ELECTRIC FEEDER RIGHT

- plastic
- power feed possible from above [ceiling] or from the side

item	colour	dimensions L x W x H	price
<b>720008</b>	<input type="checkbox"/> white	71 x 26 x 22,2 mm	<b>13,95 €</b>
<b>720009</b>	<input checked="" type="checkbox"/> black	71 x 26 x 22,2 mm	<b>13,95 €</b>

220-240 Volt	16 A	IP20
-----------------	------	------



## D ONE FLEX FEEDER WITH CEILING CANOPY

- plastic/metal
- cable length between canopy and feeder 1000 mm
- max. 1320W connected power

item	colour	dimensions W x Ø	price
<b>720010</b>	<input type="checkbox"/> white	28 x 120 x 200-1000 mm	<b>39,95 €</b>
<b>720011</b>	<input checked="" type="checkbox"/> black	28 x 120 x 200-1000 mm	<b>39,95 €</b>

220-240 Volt	6 A	IP20
-----------------	-----	------





## D ONE ELECTRICAL STRAIGHT CONNECTOR WITH CENTER FEED OPTION

• plastic

item	colour	dimensions L x W x H	price
<b>720012</b>	□ white	121 x 26 x 22,2 mm	<b>24,95 €</b>
<b>720013</b>	■ black	121 x 26 x 22,2 mm	<b>24,95 €</b>

220-240 Volt	16 A	IP20
-----------------	------	------



## D ONE ELECTRICAL JOINT

• plastic

item	colour	dimensions L x W x H	price
<b>720014</b>	□ white	62 x 26 x 22,2 mm	<b>8,95 €</b>
<b>720015</b>	■ black	62 x 26 x 22,2 mm	<b>8,95 €</b>

220-240 Volt	16 A	IP20
-----------------	------	------



## D ONE 90°-JOINT

- plastic
- power feed via ceiling possible

item	colour	alignment	dimensions L x W x H	price
<b>720016</b>	□ white	left	73 x 73 x 22,2 mm	<b>24,95 €</b>
<b>720017</b>	■ black	left	73 x 73 x 22,2 mm	<b>24,95 €</b>
<b>720018</b>	□ white	right	73 x 73 x 22,2 mm	<b>24,95 €</b>
<b>720019</b>	■ black	right	73 x 73 x 22,2 mm	<b>24,95 €</b>

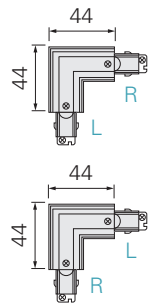
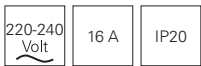

## D ONET-JOINT

- plastic
- power feed via ceiling possible

item	colour	alignment	dimensions L x W x H	price
<b>720020</b>	□ white	left-right-right	121 x 73 x 22,2 mm	<b>34,95 €</b>
<b>720021</b>	■ black	left-right-right	121 x 73 x 22,2 mm	<b>34,95 €</b>
<b>720022</b>	□ white	right-right-left	121 x 73 x 22,2 mm	<b>34,95 €</b>
<b>720023</b>	■ black	right-right-left	121 x 73 x 22,2 mm	<b>34,95 €</b>
<b>730024</b>	□ white	left-left-right	121 x 73 x 22,2 mm	<b>34,95 €</b>
<b>720025</b>	■ black	left-left-right	121 x 73 x 22,2 mm	<b>34,95 €</b>
<b>720026</b>	□ white	right-left-left	121 x 73 x 22,2 mm	<b>34,95 €</b>
<b>720027</b>	■ black	right-left-left	121 x 73 x 22,2 mm	<b>34,95 €</b>

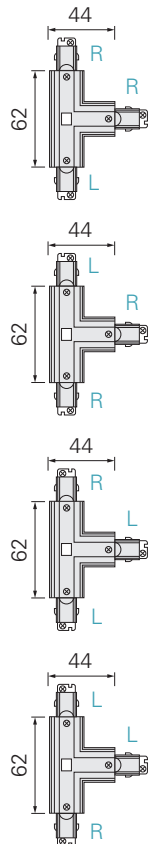
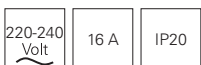



## D ONE X-JOINT

- plastic
- power feed via ceiling possible

item	colour	alignment	dimensions L x W x H	price
<b>720028</b>	□ white	left-left-right-right	121 x 121 x 22,2 mm	<b>49,95 €</b>
<b>720029</b>	■ black	left-left-right-right	121 x 121 x 22,2 mm	<b>49,95 €</b>

220-240 Volt	16 A	IP20
-----------------	------	------

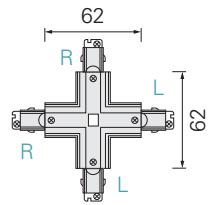

## D ONE ENDCAP

- plastic

item	colour	dimensions L x W x H	price
<b>720030</b>	□ white	15 x 26 x 22,2 mm	<b>3,95 €</b>
<b>720031</b>	■ black	15 x 26 x 22,2 mm	<b>3,95 €</b>



### D ONE 1-PHASE-ADAPTER FOR LUMINAIRE MOUNTING

- plastic / metal
- max. 10 kg/100N
- delivery includes trumpet nipple and M10 flat nut and strain relief grommet
- luminaire not included

item	colour	dimensions L x W x H	price
<b>720036</b>	<input type="checkbox"/> white	70 x 26 x 30 mm	<b>16,95 €</b>
<b>720037</b>	<input checked="" type="checkbox"/> black	70 x 26 x 30 mm	<b>16,95 €</b>

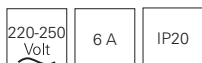





### D ONE MOUNTING BRACKET FLEX

- metal
- simplifies the assembly of more complex power rail layouts

item	colour	dimensions L x W x H	price
<b>720032</b>	□ white	30 x 28 x 10,5 mm	<b>5,95 €</b>
<b>720033</b>	■ black	30 x 28 x 10,5 mm	<b>5,95 €</b>



### D ONE ROPE SUSPENSION BRACKET MINI

- metal
- elegantly shaped and filigree suspension
- rope length: 3000 mm
- suspension dimension can be individually shortened: 70 - 3020 mm



item	colour	dimensions L x W x H	price
<b>720034</b>	□ white	120 x 28 x 70-3020 mm	<b>19,95 €</b>
<b>720035</b>	■ black	120 x 28 x 70-3020 mm	<b>19,95 €</b>

## LUCEA

For the 1-phase 230V track system, we offer the spotlights of the LUCEA series. In the version as a ceiling luminaire, they are available with 6 and 10 watts, enabling a maximum light output of up to 3000 lumens.



### LUCEA 6 + 10

- dimmable via phase cut-in or phase cut-out
- rotatable and swivelling
- aluminium diecast
- dimensions H x Ø: 249 x 65 mm

item	colour	colour temperature	light current	power	price
<b>707165</b>	white	ww 2700 K	600 lm	6 W	<b>84,95 €</b>
<b>707166</b>	black	ww 2700 K	600 lm	6 W	<b>84,95 €</b>
<b>707167</b>	white	ww 2700 K	1000 lm	10 W	<b>89,95 €</b>
<b>707168</b>	black	ww 2700 K	1000 lm	10 W	<b>89,95 €</b>

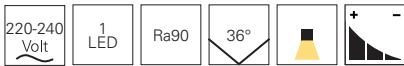

#### accessories

<b>930679</b>	lens 24° for LUCEA 6/10	<b>9,95 €</b>
<b>930752</b>	barn door for LUCEA 6/10 white	<b>22,95 €</b>
<b>930753</b>	barn door for LUCEA 6/10 black	<b>22,95 €</b>
<b>930756</b>	reflector ring for LUCEA 6/10 white	<b>4,95 €</b>
<b>930757</b>	reflector ring for LUCEA 6/10 black	<b>4,95 €</b>
<b>930758</b>	reflector ring for LUCEA 6/10 gold	<b>4,95 €</b>

## LUCEA

The matching pendant luminaires of the LUCEA series for the 1-phase 230V track system are available in the versions 6 and 10 watts and offer up to 2000 lumens of light output. The maximum suspension is 1800 mm.



### LUCEA 6 + 10

- dimmable via phase cut-in or phase cut-out
- max. suspension 1800 mm
- aluminium diecast
- dimensions H x Ø: 157 x 65 mm

item	colour	colour temperature	light current	power	price
<b>707175</b>	□ white	ww 2700 K	600 lm	6 W	<b>114,95 €</b>
<b>707176</b>	■ black	ww 2700 K	600 lm	6 W	<b>114,95 €</b>
<b>707177</b>	□ white	ww 2700 K	1000 lm	10 W	<b>119,95 €</b>
<b>707178</b>	■ black	ww 2700 K	1000 lm	10 W	<b>119,95 €</b>



#### accessories

<b>930679</b>	lens 24° for LUCEA 6/10	<b>9,95 €</b>
<b>930752</b>	barn door for LUCEA 6/10 white	<b>22,95 €</b>
<b>930753</b>	barn door for LUCEA 6/10 black	<b>22,95 €</b>
<b>930756</b>	reflector ring for LUCEA 6/10 white	<b>4,95 €</b>
<b>930757</b>	reflector ring for LUCEA 6/10 black	<b>4,95 €</b>
<b>930758</b>	reflector ring for LUCEA 6/10 gold	<b>4,95 €</b>

## SLIM

For the track system, we offer matching pendant luminaires of the SLIM series. The luminaire body made of aluminium diecast is always the same size [300 x 39mm]. The pendant luminaires for the tracks allow a maximum suspension of 1800 mm.

This makes the one-lamp SLIM track luminaires particularly suitable for restaurant and retail projects with changing room layouts. The quality of the SLIM series is rounded off by a flexible textile cable.



## SLIM

- extra soft textile cable
- glare-free, thanks to low UGR value [ $<19$ ]
- slim design with only 39 mm diameter
- aluminium diecast
- dimensions H x  $\varnothing$ : 300 x 39 mm
- max. suspension: 1800 mm
- dimmable via phase cut-in or phase cut-out

item	colour	colour temperature	light current	price
<b>707164</b>	white	ww 2700 K	500 lm	<b>89,95 €</b>
<b>707163</b>	black	ww 2700 K	500 lm	<b>89,95 €</b>

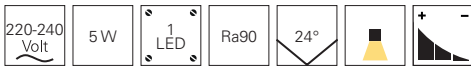

### accessories

<b>930747</b>	lens 15°	<b>4,95 €</b>
<b>930748</b>	lens 36°	<b>4,95 €</b>
<b>930749</b>	lens 60°	<b>4,95 €</b>
<b>930744</b>	reflector ring white	<b>4,95 €</b>
<b>930745</b>	reflector ring black	<b>4,95 €</b>
<b>930746</b>	reflector ring gold	<b>5,95 €</b>





## CAN

- aluminium diecast
- dimensions L x Ø: 134 x 60 mm
- dimmable with optional light source

item	colour	price
<b>707155</b>	□ white	<b>39,95 €</b>
<b>707156</b>	■ black	<b>39,95 €</b>



### accessories

<b>930301</b>	reflector ring   H: 28 mm   white	<b>4,95 €</b>
<b>930302</b>	reflector ring   H: 28 mm   black	<b>4,95 €</b>
<b>930303</b>	reflector ring   H: 28 mm   gold optics mat	<b>4,95 €</b>
<b>930366</b>	reflector ring   H: 28 mm   silver coloured	<b>4,95 €</b>



## NIHAL MINI

- rotatable and swivelling
- high tilt angle
- aluminium diecast
- dimensions L x W x H x Ø: 94 x 102 x 139 x 60 mm
- total power consumption: 8,9 W
- dimmable via phase cut-in or phase cut-out



item	colour	colour temperature	light current	price
<b>707185</b>	white	ww 2700 K	lm	<b>144,95 €</b>
<b>707186</b>	black	ww 2700 K	lm	<b>144,95 €</b>



### accessories

<b>930297</b>	side cover white	<b>3,95 €</b>
<b>930298</b>	side cover black	<b>3,95 €</b>
<b>930364</b>	side cover silver	<b>3,95 €</b>
<b>930299</b>	side cover gold	<b>3,95 €</b>
<b>930300</b>	side cover walnut look	<b>5,95 €</b>
<b>930768</b>	side cover oak wood look natural	<b>5,95 €</b>
<b>930301</b>	reflector ring white	<b>4,95 €</b>
<b>930302</b>	reflector ring black	<b>4,95 €</b>
<b>930303</b>	reflector ring gold	<b>4,95 €</b>
<b>930366</b>	reflector ring silver	<b>4,95 €</b>
<b>930765</b>	reflector 24°	<b>10,95 €</b>
<b>930305</b>	reflector 36°	<b>3,60 €</b>
<b>930306</b>	reflector 48°	<b>8,95 €</b>
<b>930307</b>	honeycomb filter	<b>8,95 €</b>
<b>930308</b>	Spread Lens	<b>10,95 €</b>
<b>930309</b>	Softening Lens	<b>10,95 €</b>
<b>930310</b>	Linear Spread Lens	<b>10,95 €</b>
<b>930767</b>	Lens 12°	<b>10,95 €</b>



### UNI II MINI

- rotatable and swivelling
- dimmable via phase cut-in or phase cut-out
- aluminium diecast
- dimensions T x H x Ø: 160 x 75 x 91 mm
- total power consumption: 8,9 W

item	colour	colour temperature	light current	price
707187	white	ww 2700 K	1m	129,95 €
707188	black	ww 2700 K	1m	129,95 €

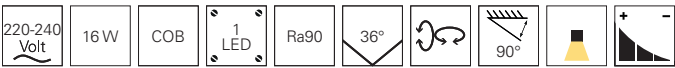

#### accessories

930330	reflector ring white	10,95 €
930331	reflector ring black	10,95 €
930333	reflector ring chrome	10,95 €
930332	reflector ring gold	10,95 €
930381	reflector ring II black	10,95 €
930326	cover back white	3,55 €
930327	cover back black	3,45 €
930328	cover heat sink white	3,55 €
930329	cover heat sink black	2,95 €
930770	reflector 24°	10,95 €
930771	reflector 48°	10,95 €



# 3-phases power luminaires











with the kind support of Küchen Leicht Ettlingen



## LINEAR 60 + 100

• aluminium

item	colour	colour temperature	light current	dimensions L x W x H	power	price
<b>707147</b>	<input type="checkbox"/> white	 3000 K	2000 lm	687 x 33 x 52 mm	18 W	<b>139,95 €</b>
<b>707149</b>	<input type="checkbox"/> white	 4000 K	2100 lm	687 x 33 x 52 mm	18 W	<b>139,95 €</b>
<b>707148</b>	<input checked="" type="checkbox"/> black	 3000 K	2000 lm	687 x 33 x 52 mm	18 W	<b>139,95 €</b>
<b>707150</b>	<input checked="" type="checkbox"/> black	 4000 K	2100 lm	687 x 33 x 52 mm	18 W	<b>139,95 €</b>
<b>707151</b>	<input type="checkbox"/> white	 3000 K	3200 lm	1087 x 33 x 52 mm	28 W	<b>179,95 €</b>
<b>707153</b>	<input type="checkbox"/> white	 4000 K	3300 lm	1087 x 33 x 52 mm	28 W	<b>179,95 €</b>
<b>707152</b>	<input checked="" type="checkbox"/> black	 3000 K	3200 lm	1087 x 33 x 52 mm	28 W	<b>179,95 €</b>
<b>707154</b>	<input checked="" type="checkbox"/> black	 4000 K	3300 lm	1087 x 33 x 52 mm	28 W	<b>179,95 €</b>

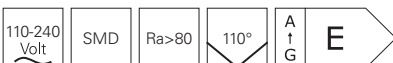

## LINEAR PRO TILT

The LINEAR PRO TILT 3-phase track luminaire is the ideal solution for the illumination of retail shelves. This luminaire offers a perfect combination of functionality and versatility. It can be locked in a downwards position or tilted by up to 30° to either side to direct the light precisely. Thanks to its BEG eligibility, you can benefit from financial advantages. With a long service life of 60,000 hours [L80B50], this luminaire is a long-term investment. The output is adjustable in three steps [except for the DALI models] to optimally adapt the illumination to the requirements. The 1500 mm versions have a sliding track adapter and are each available in 50% mirrored A/B versions for seamless alignment even across track connectors. The LINEAR PRO TILT track luminaire - professional lighting for retail shelving with maximum flexibility.

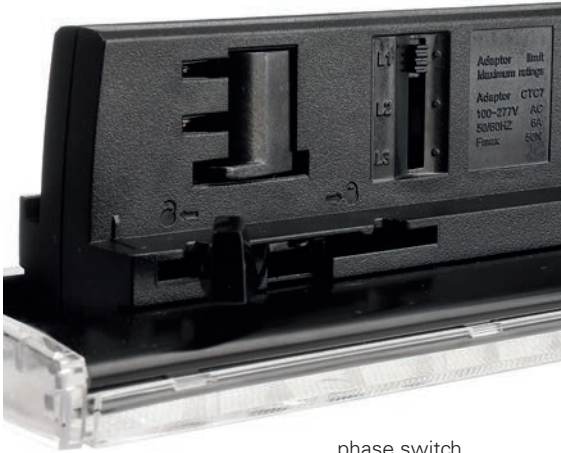

phase switch



dip switch





## LINEAR PRO TILT

- BEG eligible
- lockable downwards
- swivels up to 30° per side
- long service life 60,000 h [L80B50]
- particularly energy-efficient
- power adjustable in three steps [except DALI models]
- steel

item	colour	colour temperature	light current	dimensions L x L x H	power	control	price
707141	white	4000 K	3400 lm	600 x 60 x 54 mm	20 W		<b>149,95 €</b>
707142	black	4000 K	3400 lm	600 x 60 x 54 mm	20 W		<b>149,95 €</b>
707143	white	4000 K	8000 lm	1493 x 60 x 54 mm	50 W		<b>184,95 €</b>
707144	black	4000 K	8000 lm	1493 x 60 x 54 mm	50 W		<b>184,95 €</b>
707145	white	4000 K	8000 lm	1493 x 60 x 54 mm	50 W	DALI 2 / DT6	<b>214,95 €</b>
707146	black	4000 K	8000 lm	1493 x 60 x 54 mm	50 W	DALI 2 / DT6	<b>214,95 €</b>







## SLIM

For the track system, we offer matching pendant luminaires of the SLIM series. The luminaire body made of die-cast aluminium is always the same size [300 x 39mm]. The pendant luminaires for the track system allow for a maximum suspension of 180 cm. This makes the single-flame SLIM track luminaire particularly suitable for gastronomy and retail projects with changing room layout. The quality of the SLIM series is rounded off by a flexible textile cable.





## SLIM

- particularly soft textile cable
- glare-free thanks to low UGR value [ $<19$ ]
- slim design with a diameter of only 39 mm
- aluminium diecast
- dimensions H x  $\varnothing$ : 300 x 39 mm
- max. suspension: 1800 mm

item	colour	colour temperature	light current	control	price
<b>707162</b>	<input type="checkbox"/> white	2700 K	500 lm	dimming	<b>89,95 €</b> <b>NEW</b>
<b>707161</b>	<input checked="" type="checkbox"/> black	2700 K	500 lm	dimming	<b>89,95 €</b> <b>NEW</b>
<b>707133</b>	<input type="checkbox"/> white	3000 K	500 lm		<b>84,95 €</b>
<b>707132</b>	<input checked="" type="checkbox"/> black	3000 K	500 lm		<b>84,95 €</b>

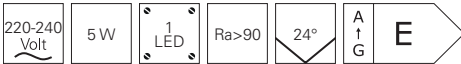

### accessories

<b>930747</b>	lens 15°	<b>4,95 €</b>
<b>930748</b>	lens 36°	<b>4,95 €</b>
<b>930749</b>	lens 60°	<b>4,95 €</b>
<b>930744</b>	reflector ring white	<b>4,95 €</b>
<b>930745</b>	reflector ring black	<b>4,95 €</b>
<b>930746</b>	reflector ring gold	<b>5,95 €</b>



## CANIS

Discover our portable LED battery lights of the CANIS series. With 3.5 W power and 270 lm brightness, our luminaires offer a particularly wide and pleasant light distribution. Thanks to the infinitely dimming function via the practical touch sensor, you can adjust the lighting according to your preferences. Simply switch between 2 light colour levels, to create the perfect atmosphere. And the best part? One rechargeable battery lasts for more than eight hours of illumination. With the optional charging station, you can charge up to six luminaires at the same time and always have enough light sources available. Choose from eight different colours, including trendy pastel shades, to emphasise your personal style.





light colour adjustable in two steps



## CANIS

- **USB charging base not included [optional]**
- pleasant and wide light distribution
- more than 8 h light duration after charging
- continuously dimmable via touch sensor
- light colour adjustable in two steps
- optional stackable 6-compartment charging station
- aluminium diecast
- dimensions H x Ø: 356 x 112 mm

item	colour	colour temperature	light current	price
346049	white matt	2200/3000 K	270 lm	99,95 €
346050	black matt	2200/3000 K	270 lm	99,95 €
346051	dark grey matt	2200/3000 K	270 lm	99,95 €
346022	beige matt	2200/3000 K	270 lm	99,95 €
346045	mint green matt	2200/3000 K	270 lm	99,95 €
346046	Terracotta matt	2200/3000 K	270 lm	99,95 €
346047	blue matt	2200/3000 K	270 lm	99,95 €
346048	rust-coloured matt	2200/3000 K	270 lm	99,95 €



### accessories

- 930714** USB charging socket with USB A without power supply **11,95 €**
- 930716** 6-fold charging station incl. power supply **199,95 €**





## CANIS MINI

Discover our portable LED battery lights of the CANIS series. With 2.3 W power and 110 lm brightness, our luminaires offer a particularly wide and pleasant light distribution. Thanks to the infinitely dimming function via the practical touch sensor, you can adjust the lighting according to your preferences. Simply switch between 2 light colour levels, to create the perfect atmosphere. And the best part? One rechargeable battery lasts for more than eight hours of illumination. With the optional charging station, you can charge up to fifteen luminaires at the same time and always have enough light sources available. Choose from eight different colours, including trendy pastel shades, to emphasise your personal style.





## CANIS MINI

- USB charging base not included [optional]
- pleasant and wide light distribution
- more than 8 h light duration after charging
- continuously dimmable via touch sensor
- light colour adjustable in two steps
- optional stackable 15-compartment charging station
- aluminium diecast
- dimensions H x Ø: 208 x 76 mm

item	colour	colour temperature	light current	price
346082	white matt	2200/3000 K	110 lm	89,95 €
346083	black matt	2200/3000 K	110 lm	89,95 €
346084	dark grey matt	2200/3000 K	110 lm	89,95 €
346077	beige matt	2200/3000 K	110 lm	89,95 €
346078	mint green matt	2200/3000 K	110 lm	89,95 €
346079	Terracotta matt	2200/3000 K	110 lm	89,95 €
346080	blue matt	2200/3000 K	110 lm	89,95 €
346081	rust-coloured matt	2200/3000 K	110 lm	89,95 €



2,3 W	3,7 Volt		Ra80			IP65
-------	----------	--	------	--	--	------



### accessories

- 930732 USB charging socket with USB A without power supply
- 930734 15-fold charging station incl. power supply

9,95 €

299,95 €





## FARO

- glare-free, downward directed light [>97%]
- lens optics for particularly wide homogeneous illumination with up to 10 / 7 / 4 m diameter
- optional shielding screen for half-sided darkening
- aluminium diecast
- DALI 2 dimmable
- IP68 connection box with through-wiring
- particularly high-quality surface and solid construction
- dirt-repellent powder coating in DB703

item	colour	colour temperature	light current	control	dimensions H x Ø	price
<b>730492</b>	■ dark grey	ww 3000 K	1124 lm	DALI 2 / DT6	250 x 180 mm	<b>429,95 €</b>
<b>730493</b>	■ dark grey	ww 3000 K	1124 lm	DALI 2 / DT6	600 x 180 mm	<b>499,95 €</b>
<b>730494</b>	■ dark grey	ww 3000 K	1124 lm	DALI 2 / DT6	1000 x 180 mm	<b>579,95 €</b>

220-240 Volt	24W	Ra80	180/360°			IP65	IK08
--------------	-----	------	----------	--	--	------	------

### accessories

- 930731** concrete anchor
- 930776** shielding aperture 180°

**24,95 €**  
**9,95 €**









## LERNA

The bollard luminaires of the LERNA series offer a variety of advantages. The fully downward directed light ensures efficient lighting without light pollution. The LERNA series is available in two different heights [600 mm and 1000 mm] to meet your individual requirements. With an output of 6 W and 516 lm, the luminaire itself offers excellent brightness.

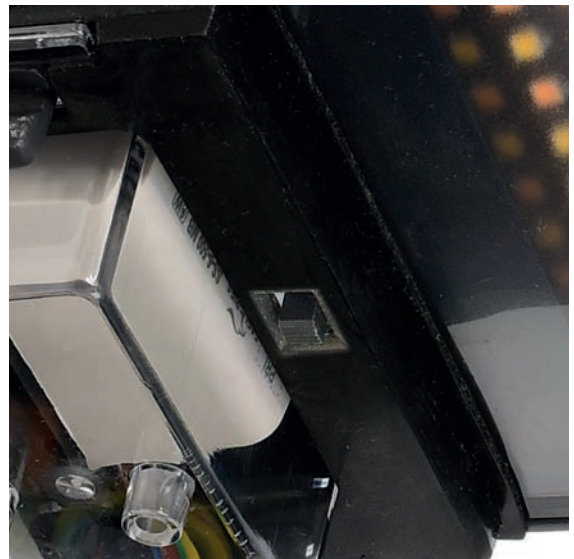



## LERNA

- light colour adjustable in two levels
- 100% downward directed light, therefore no light pollution
- aluminium diecast

item	colour	colour temperature	light current	dimensions L x W x H	price
<b>733073</b>	■ dark grey	■ WW ■ NW 3000/4000 K	516 lm	120 x 100 x 600 mm	<b>199,95 €</b>
<b>733072</b>	■ dark grey	■ WW ■ NW 3000/4000 K	516 lm	120 x 100 x 1000 mm	<b>249,95 €</b>







## LERNA

The LERNA is a tall, rectangular outdoor light fixture that provides a warm, ambient glow. It is designed to be used in a variety of outdoor settings, including patios, decks, and walkways. The LERNA is made of high-quality materials and is built to last. It is also easy to install and maintain. The LERNA is a great choice for anyone looking for a stylish and functional outdoor light fixture.

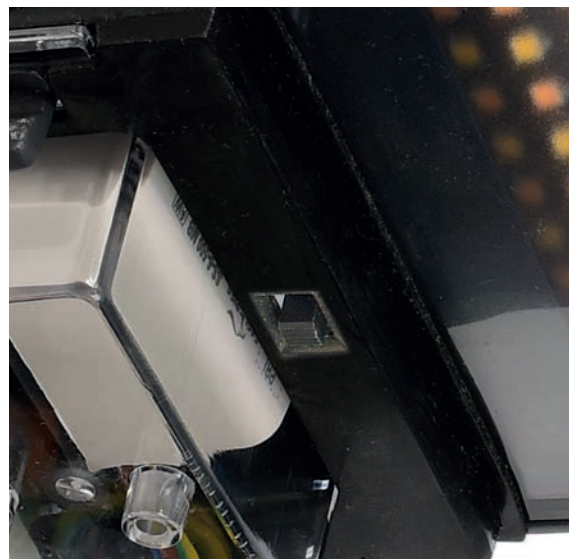





## LERNA

- Luminaire à prise de courant rotative séparément
- Boîte de dérivation placée dans le couvercle
- Puissance totale de 360W
- Hauteur réglable à deux niveaux
- 100% de lumière dirigée vers le bas, donc pas de pollution lumineuse
- Aluminium anodisé sous pression
- Luminaire et prise de courant séparés (L séparé)

Article	couleur	Température	Flux lumineux	Dimensions H	prix
733071	gris foncé	3000/4000 K	516 lm	600 mm	259,95 €
733070	gris foncé	3000/4000 K	516 lm	1000 mm	299,95 €





NEW



## TABIT

- paving stone look
- suitable for common plaster dimensions
- incl. 30 cm connection cable with open cable ends
- not passable
- Polycarbonat

item	colour	colour temperature	light current	dimensions L x L x H	power EEI	price
<b>730480</b>	<input checked="" type="checkbox"/> colourless satin	3000 K	120 lm	100 x 100 x 68 mm	1,50 W F	<b>29,95 €</b>
<b>730481</b>	<input checked="" type="checkbox"/> colourless satin	3000 K	240 lm	200 x 100 x 68 mm	2,9 W E	<b>59,95 €</b>
<b>730482</b>	<input checked="" type="checkbox"/> colourless satin	3000 K	240 lm	200 x 200 x 68 mm	2,9 W E	<b>99,95 €</b>







# PLANO LUMINAIRE SYSTEM

Whether as a recessed version, surface-mounted ceiling luminaire or pendant luminaire as well as for wall mounting: the PLANO series is more than just another combination of profile and LED strip and is produced entirely in Europe. The linear lighting solutions are based on four different profiles and can be configured individually. Thus, there are hardly any limits to the possible applications - whether in the office, in schools, in private living areas, in stores, showrooms and many more.



## INDIVIDUAL SOLUTION

A PLANO profile luminaire always has the same design - and yet it is individual. Inside sits a profile with LED illumination in 2,700, 3,000 or 4,000 K. The surrounding luminaire body is made of extruded aluminum and has an anodized or powder-coated surface. You can individually determine the length, equipment as well as the basic shape of the body, because the PLANO series is an individual lighting solution.

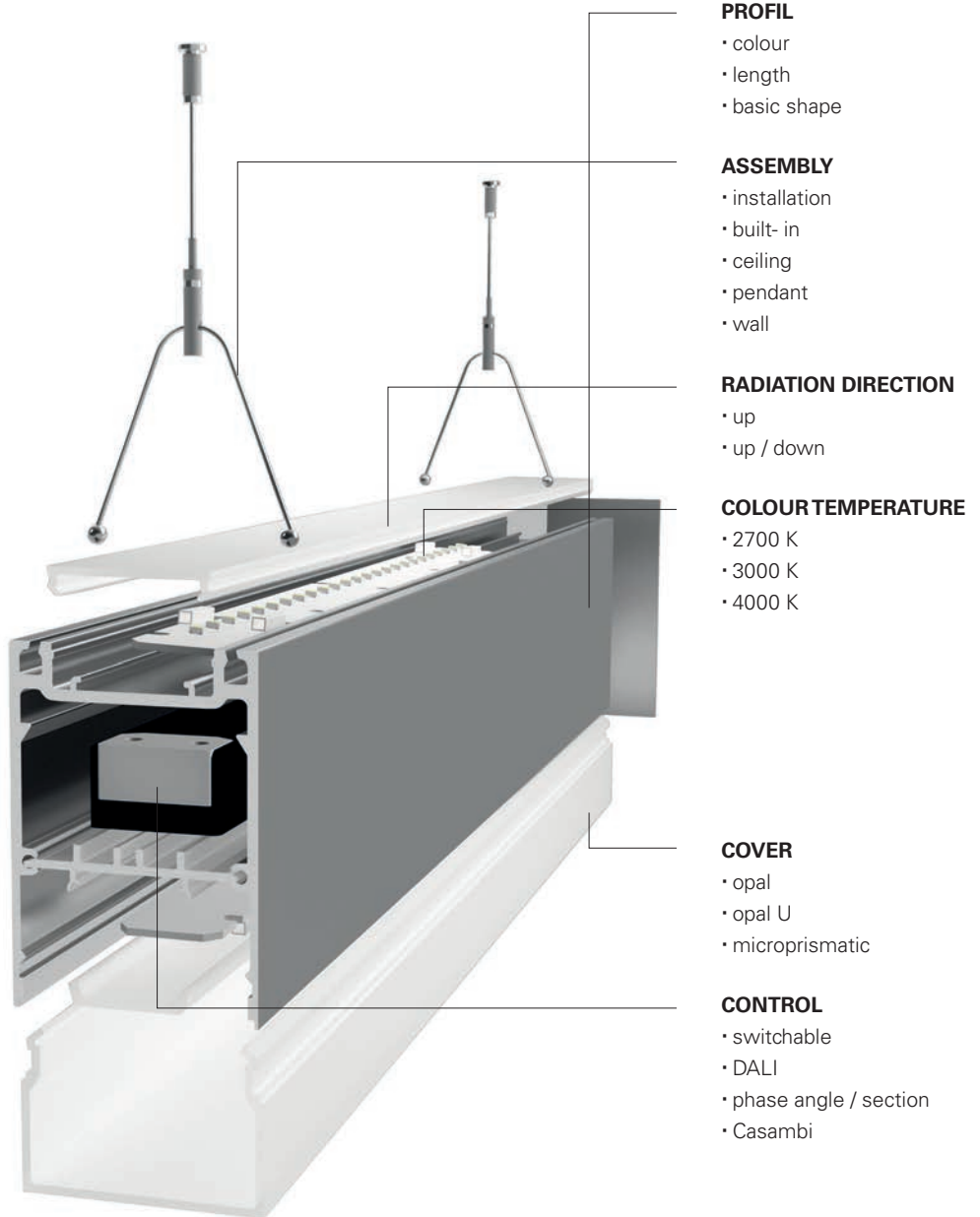



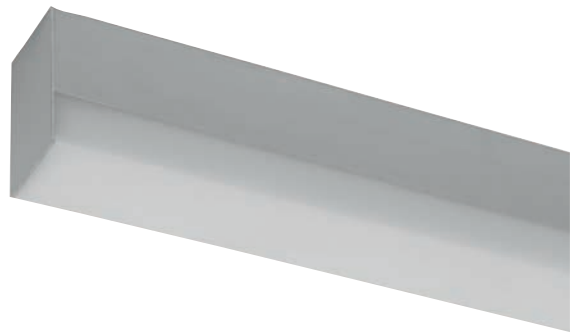
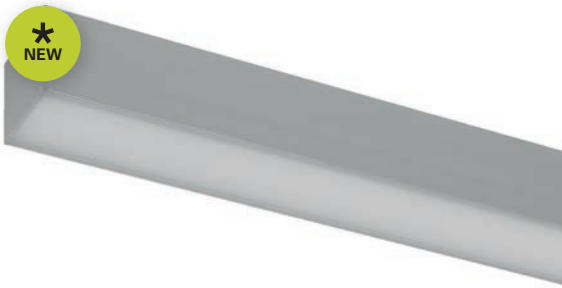

## PLANO DS LUMINAIRE SYSTEM

- aluminium die casting
- direct light

assembly				cover			length	radiation dir.		colour	colour temperature			control			
ceiling structure	pendulum	wall structure	ceiling mounting	opal	opal U	microprismatic	individual	down	up+down	individual	2700 K	3000 K	4000 K	switchable	DALI	phase angle/section	Casambi
x	x			x	x	x	x	x		x	x	x	x	x	x	x	x

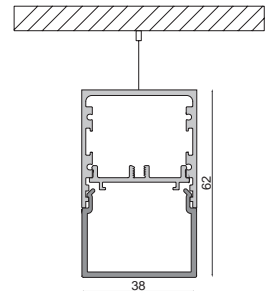
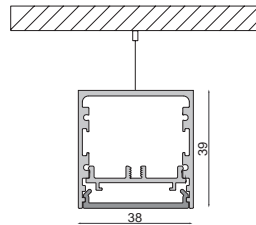
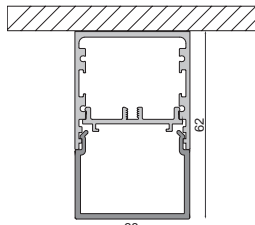
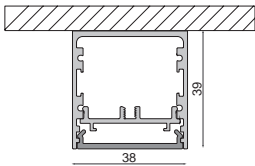
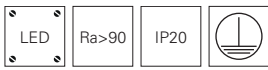

### CONFIGURATION EXAMPLE

- DS surface-mounted luminaire | 2400 mm | black
- 74 W
- 3000 K | 6827 lm
- EVG | DALI
- incl. U-cover opal
- incl. end caps

#### price on demand

Of course, you can configure our PLANO system entirely according to your wishes and circumstances.

with the kind support of WIBU-SYSTEMS AG Karlsruhe



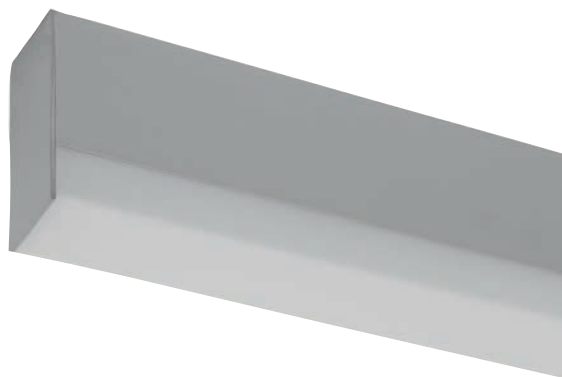
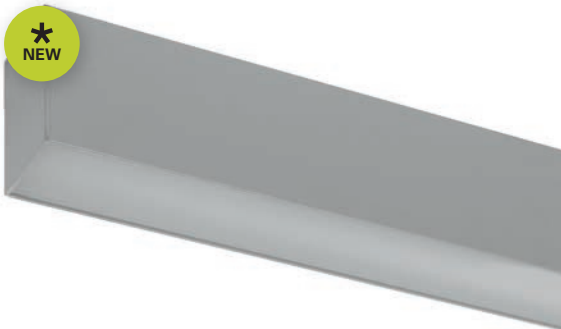

## PLANO ES LUMINAIRE SYSTEM

- aluminium die casting
- direct light

assembly				cover			length	radiation dir.		colour	colour temperature			control			
ceiling structure	pendulum	wall structure	ceiling mounting	opal	opal U	microprismatic	individual	down	up+down	individual	2700 K	3000 K	4000 K	switchable	DALI	phase angle/section	Casambi
x	x			x	x	x	x	x	x	x	x	x	x	x	x	x	x

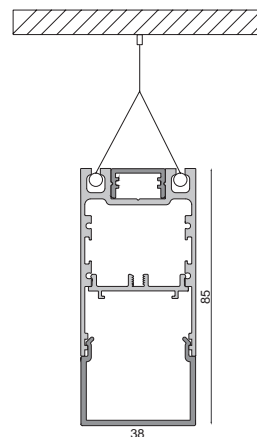
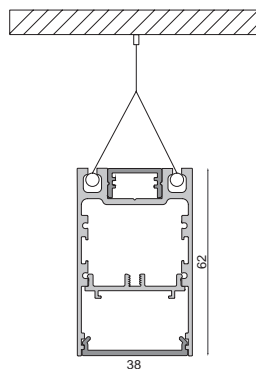
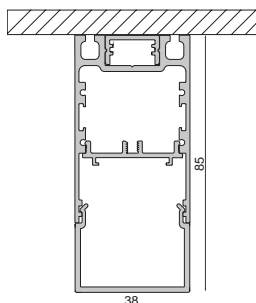
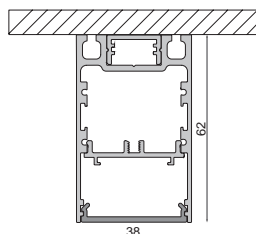
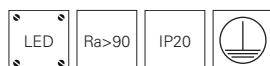

### CONFIGURATION EXAMPLE

- ES surface-mounted luminaire | 2400 mm | black
- 74 W
- 3000 K | 5425 lm
- EVG | DALI
- incl. U-cover flat opal
- incl. end caps

#### price on demand

Of course, you can configure our PLANO system entirely according to your wishes and circumstances.







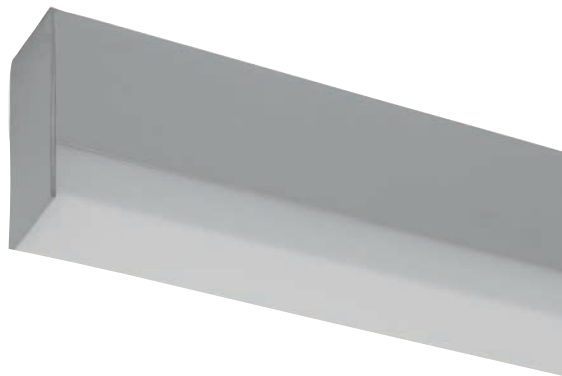
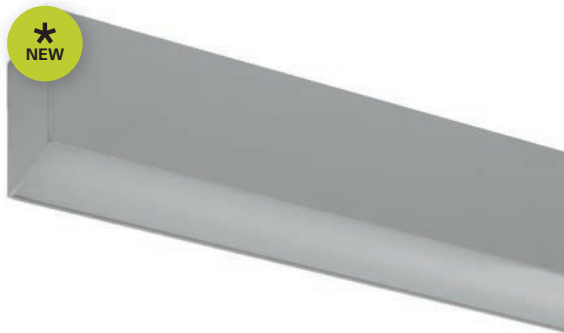

## PLANO ES LUMINAIRE SYSTEM

- aluminium die casting
- direct light

assembly				cover			length	radiation dir.		colour	colour temperature			control			
ceiling structure	pendulum	wall structure	ceiling mounting	opal	opal U	microprismatic	individual	down	up+down	individual	2700 K	3000 K	4000 K	switchable	DALI	phase angle/section	Casambi
		X		X	X	X	X	X	X	X	X	X	X	X	X	X	X

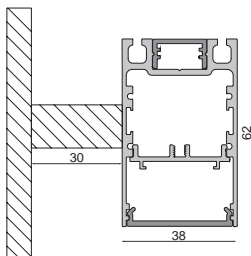
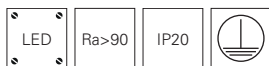

### CONFIGURATION EXAMPLE

- ES wall-mounted luminaire | 2400 mm | black
- 97 W
- 3000 K | 7201 lm
- EVG | DALI
- incl. U-cover flat opal
- incl. end caps and wall bracket

#### price on demand

Of course, you can configure our PLANO system entirely according to your wishes and circumstances.





## PLANO ES RECESSED LUMINAIRE SYSTEM

- aluminium die casting
- direct light

assembly				cover			length	radiation dir.		colour	colour temperature			control			
ceiling structure	pendulum	wall structure	ceiling mounting	opal	opal U	microprismatic	individual	down	up+down	individual	2700 K	3000 K	4000 K	switchable	DALI	phase angle/section	Casambi
			X	X	X	X	X	X		X	X	X	X	X	X	X	X

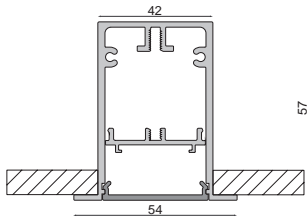
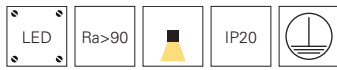

### CONFIGURATION EXAMPLE

- ES recessed ceiling luminaire | 2400 mm | black
- 97 W
- 3000 K | 7201 lm
- EVG | DALI
- incl. U-cover flat opal
- incl. end caps and mounting bracket

#### price on demand

Of course, you can configure our PLANO system entirely according to your wishes and circumstances.





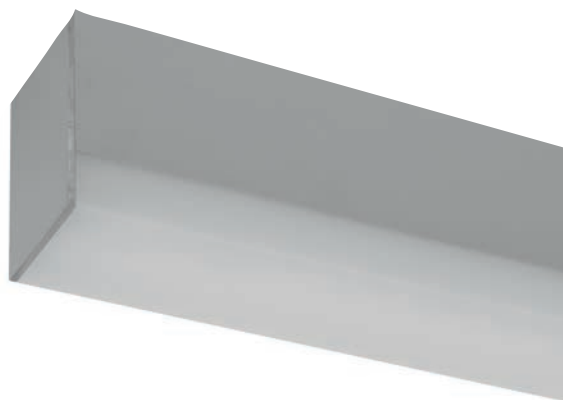
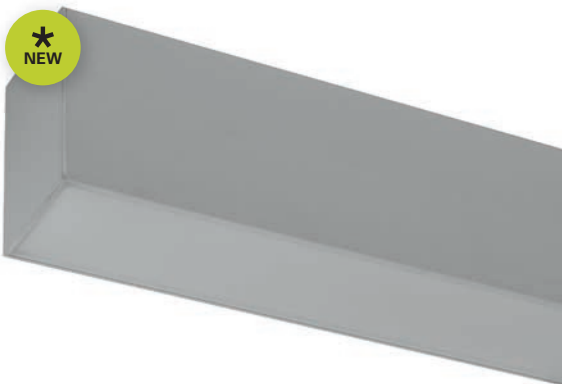

assembly				cover			length	radiation dir.		colour	colour temperature			control			
ceiling structure	pendulum	wall structure	ceiling mounting	opal	opal U	microprismatic	individual	down	up+down	individual	2700 K	3000 K	4000 K	switchable	DALI	phase angle/section	Casambi
x	x			x	x	x	x	x	x	x	x	x	x	x	x	x	x

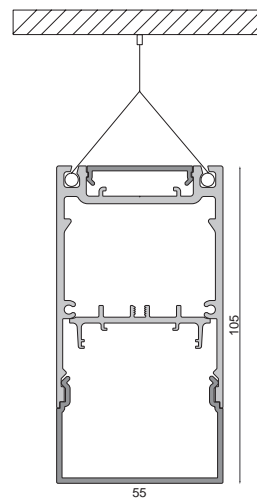
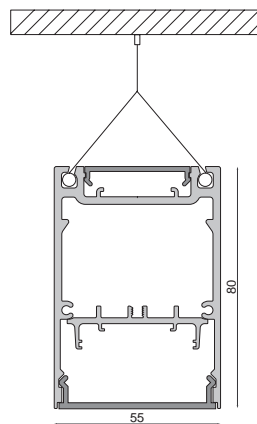
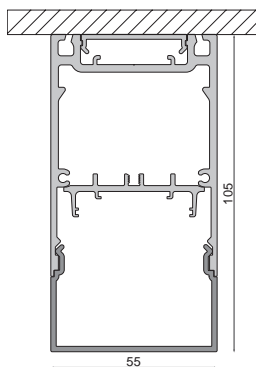
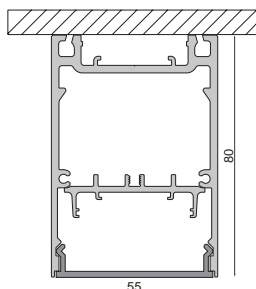
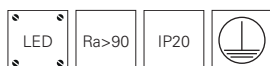

## CONFIGURATION EXAMPLE

- MS surface-mounted luminaire | 2400 mm | black
- 74 W
- 3000 K | 6990 lm
- EVG | DALI
- incl. U-cover opal
- incl. end caps

### price on demand

Of course, you can configure our PLANO system entirely according to your wishes and circumstances.



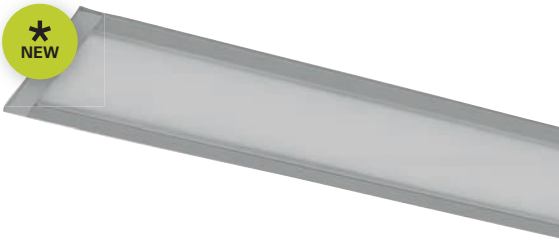

## PLANO MS RECESSED LUMINAIRE SYSTEM

- aluminium die casting
- direct light

assembly				cover			length	radiation dir.		colour	colour temperature			control			
ceiling structure	pendulum	wall structure	ceiling mounting	opal	opal U	microprismatic	individual	down	up+down	individual	2700 K	3000 K	4000 K	switchable	DALI	phase angle/section	Casambi
			X	X	X	X	X	X		X	X	X	X	X	X	X	X

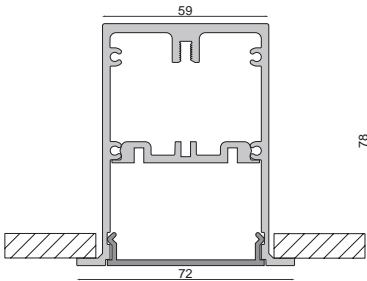

### CONFIGURATION EXAMPLE

- MS recessed ceiling luminaire | 2400 mm | black
- 74 W
- 3000 K | 6990 lm
- EVG | DALI
- incl. U-cover opal
- incl. end caps and mounting bracket

#### price on demand

Of course, you can configure our PLANO system entirely according to your wishes and circumstances.







## PLANO BSH LUMINAIRE SYSTEM

- aluminium die casting
- direct light

assembly				cover			length	radiation dir.		colour	colour temperature			control			
ceiling structure	pendulum	wall structure	ceiling mounting	opal	opal U	microprismatic	individual	down	up+down	individual	2700 K	3000 K	4000 K	switchable	DALI	phase angle/section	Casambi
		X		X	X	X	X	X	X	X	X	X	X	X	X	X	X

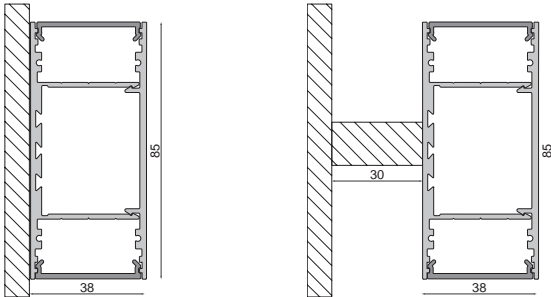

### CONFIGURATION EXAMPLE

- BSH wall-mounted luminaire | 2400 mm | black
- 174 W,
- 3000 K | 10822 lm
- EVG | DALI
- incl. U-cover opal
- incl. end caps

#### price on demand

Of course, you can configure our PLANO system entirely according to your wishes and circumstances.



Foto: Visione.ch

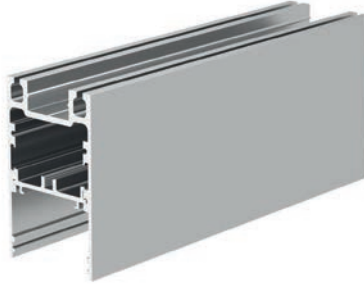
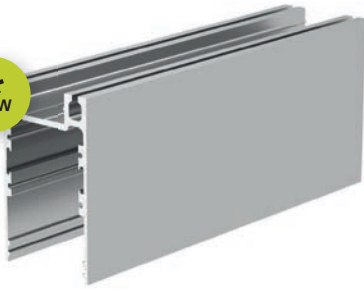

## PLANO ES

- universal luminaire profile
- uplight for LED stripes up to 15 mm wide
- downlight for LED stripes up to 22 mm wide
- incl. LED support

item	colour	dimensions L	price
<b>970572</b>	aluminium anodised	2000 mm	<b>129,95 €</b>
<b>970573</b>	aluminium anodised	2500 mm	<b>159,95 €</b>
<b>970574</b>	black	2000 mm	<b>129,95 €</b>
<b>970575</b>	black	2500 mm	<b>159,95 €</b>

other colours on request

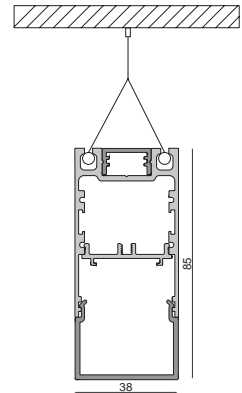
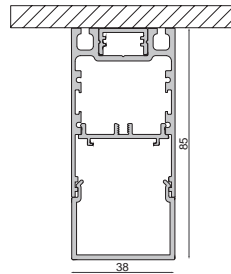
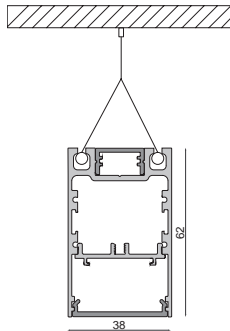
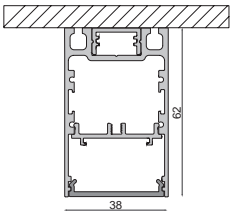

### accessories

<b>840192</b>	LED stripe   5m   24V   2700K   66 lm/W   1215 lm/m   18,5 W/m   240 LED/m	<b>164,95 €</b>
<b>840193</b>	LED stripe   5m   24V   3000K   84 lm/W   1605 lm/m   19,0 W/m   240 LED/m	<b>164,95 €</b>
<b>840194</b>	LED stripe   5m   24V   4000K   89 lm/W   1770 lm/m   20,0 W/m   240 LED/m	<b>164,95 €</b>
<b>862124</b>	power supply long-flat   24V   45 W	<b>49,95 €</b>
<b>862094</b>	power supply long-flat   24V   60 W	<b>59,95 €</b>
<b>862126</b>	power supply long-flat   24V   100 W	<b>96,95 €</b>
<b>862173</b>	power supply long-flat   24V   150 W	<b>129,95 €</b>
<b>988095</b>	PLANO ES wire suspension   set	<b>49,95 €</b>

further LED strips in additional light colours [CCT/RGB/RGBW] and wattages as well as dimmable power supply units and controls on request

**covers** | PMMA [Polymethyl methacrylate]  
for Luminaire profile PLANO ES



opal      microprismatic

			
2000 mm	<b>988086</b>	<b>39,95 €</b>	
2500 mm	<b>988087</b>	<b>49,95 €</b>	

			
2000 mm	<b>988088</b>	<b>84,95 €</b>	
2500 mm	<b>988089</b>	<b>104,95 €</b>	

			
2000 mm	<b>988090</b>	<b>69,95 €</b>	
2500 mm	<b>988091</b>	<b>84,95 €</b>	

**end cap** | 1 piece  
aluminium

	aluminium anodised	<b>988092</b>	<b>24,95 €</b>
	black	<b>988093</b>	<b>24,95 €</b>



With the kind support of WIBU-SYSTEMS AG Karlsruhe



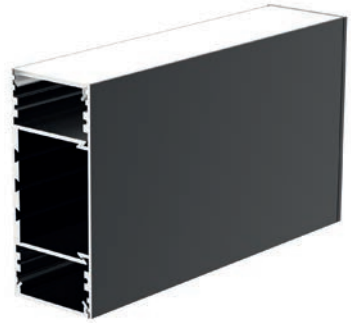
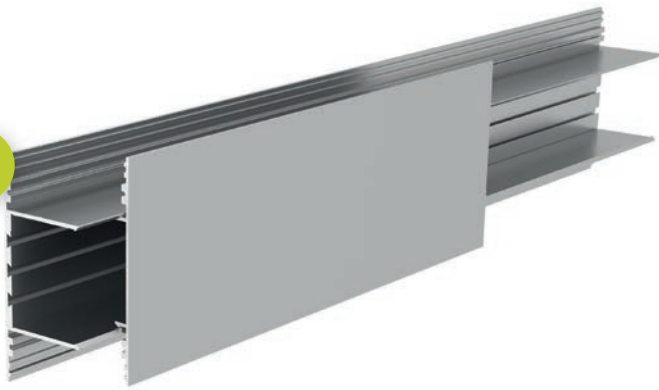

## PLANO BSH

- universal luminaire profile
- uplight for LED stripes up to 31 mm wide
- downlight for LED stripes up to 31 mm wide
- incl. LED support

item	colour	dimensions L	price
<b>970584</b>	aluminium anodised	2000 mm	<b>139,95 €</b>
<b>970585</b>	aluminium anodised	2500 mm	<b>169,95 €</b>
<b>970586</b>	black	2000 mm	<b>199,95 €</b>
<b>970587</b>	black	2500 mm	<b>249,95 €</b>

other colours on request

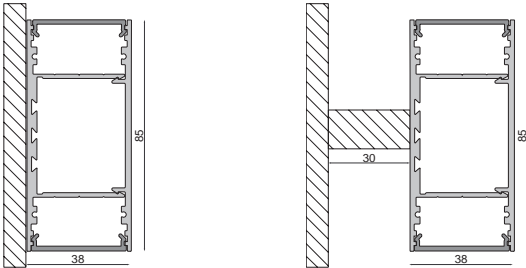



### accessories

<b>840192</b>	LED stripe   5m   24V   2700K   66 lm/W   1215 lm/m   18,5 W/m   240 LED/m	<b>164,95 €</b>
<b>840193</b>	LED stripe   5m   24V   3000K   84 lm/W   1605 lm/m   19,0 W/m   240 LED/m	<b>164,95 €</b>
<b>840194</b>	LED stripe   5m   24V   4000K   89 lm/W   1770 lm/m   20,0 W/m   240 LED/m	<b>164,95 €</b>
<b>862124</b>	power supply long-flat   24V   45 W	<b>49,95 €</b>
<b>862094</b>	power supply long-flat   24V   60 W	<b>59,95 €</b>
<b>862126</b>	power supply long-flat   24V   100 W	<b>96,95 €</b>
<b>862173</b>	power supply long-flat   24V   150 W	<b>129,95 €</b>

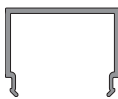

further LED strips in additional light colours [CCT/RGB/RGBW] and wattages as well as dimmable power supply units and controls on request

**covers** | PMMA [Polymethyl methacrylate]  
for luminaire profile PLANO BSH

opal      microprismatic

			
2000 mm	<b>988086</b>		<b>39,95 €</b>
2500 mm	<b>988087</b>		<b>49,95 €</b>
			
2000 mm	<b>988088</b>		<b>84,95 €</b>
2500 mm	<b>988089</b>		<b>104,95 €</b>
			
2000 mm	<b>988090</b>		<b>69,95 €</b>
2500 mm	<b>988091</b>		<b>84,95 €</b>

**end cap** | 1 piece  
aluminium

	aluminium anodised	<b>988106</b>	<b>24,95 €</b>
	black	<b>988107</b>	<b>29,95 €</b>

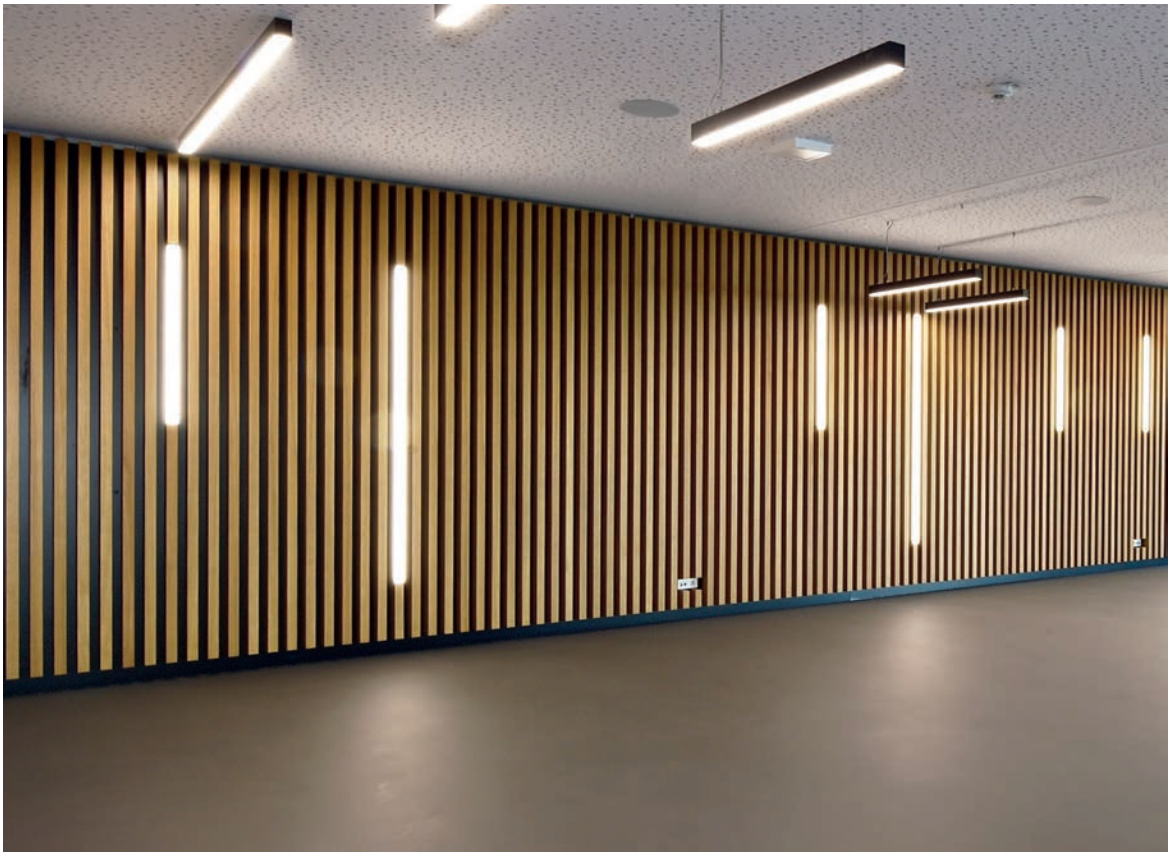

With the kind support of WIBU-SYSTEMS AG Karlsruhe

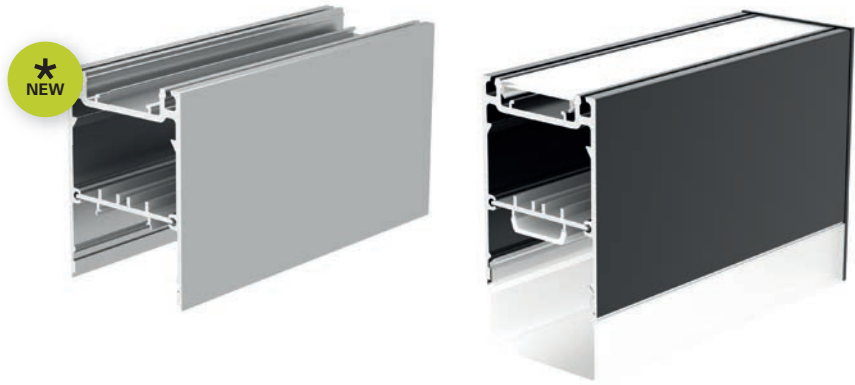

## PLANO MS

- universal luminaire profile
- uplight for LED stripes up to 24 mm wide
- downlight for LED stripes up to 24 mm wide
- incl. LED support

item	colour	dimensions L	price
<b>970578</b>	■ aluminium anodised	2000 mm	<b>274,95 €</b>
<b>970579</b>	■ aluminium anodised	2500 mm	<b>339,95 €</b>
<b>970580</b>	■ black	2000 mm	<b>274,95 €</b>
<b>970581</b>	■ black	2500 mm	<b>339,95 €</b>

other colours on request

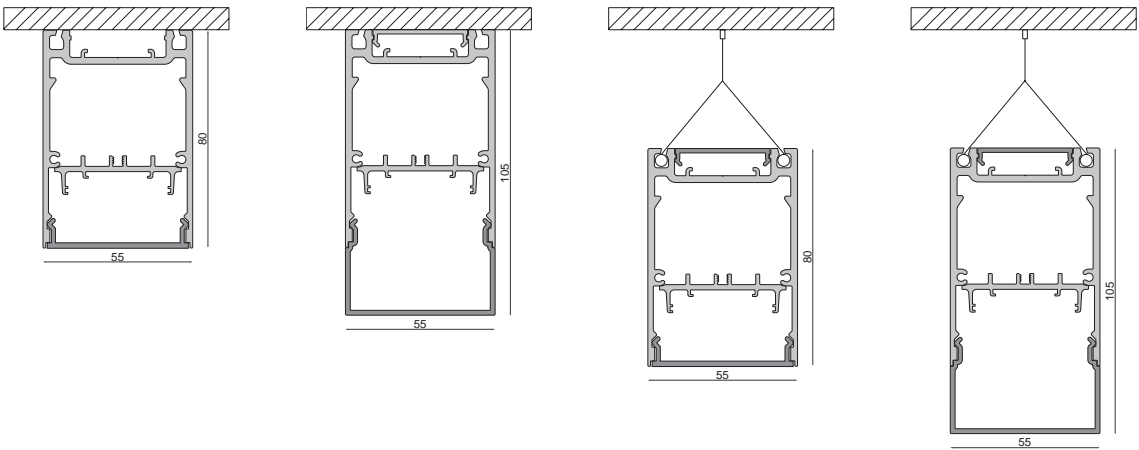

### accessories

<b>840192</b>	LED stripe   5m   24V   2700K   66 lm/W   1215 lm/m   18,5 W/m   240 LED/m	<b>164,95 €</b>
<b>840193</b>	LED stripe   5m   24V   3000K   84 lm/W   1605 lm/m   19,0 W/m   240 LED/m	<b>164,95 €</b>
<b>840194</b>	LED stripe   5m   24V   4000K   89 lm/W   1770 lm/m   20,0 W/m   240 LED/m	<b>164,95 €</b>
<b>862124</b>	power supply long-flat   24V   45 W	<b>49,95 €</b>
<b>862094</b>	power supply long-flat   24V   60 W	<b>59,95 €</b>
<b>862126</b>	power supply long-flat   24V   100 W	<b>96,95 €</b>
<b>862173</b>	power supply long-flat   24V   150 W	<b>129,95 €</b>
<b>862265</b>	power supply long-flat   24V   240 W	<b>159,95 €</b>
<b>988105</b>	PLANO ES wire suspension   set	<b>49,95 €</b>

further LED strips in additional light colours [CCT/RGB/RGBW] and wattages as well as dimmable power supply units and controls on request

**covers** | PMMA [Polymethyl methacrylate]  
for luminaire profile Plano MS

opal      microprismatic



2000 mm	<b>988096</b>	<b>49,95 €</b>
2500 mm	<b>988097</b>	<b>64,95 €</b>





2000 mm	<b>988098</b>	<b>99,95 €</b>
2500 mm	<b>988099</b>	<b>124,95 €</b>



2000 mm	<b>988100</b>	<b>69,95 €</b>
2500 mm	<b>988101</b>	<b>84,95 €</b>

**end cap** | 1 piece  
aluminium

 aluminium anodised	<b>988102</b>	<b>24,95 €</b>
 black	<b>988103</b>	<b>29,95 €</b>

With the kind support of WIBU-SYSTEMS AG Karlsruhe

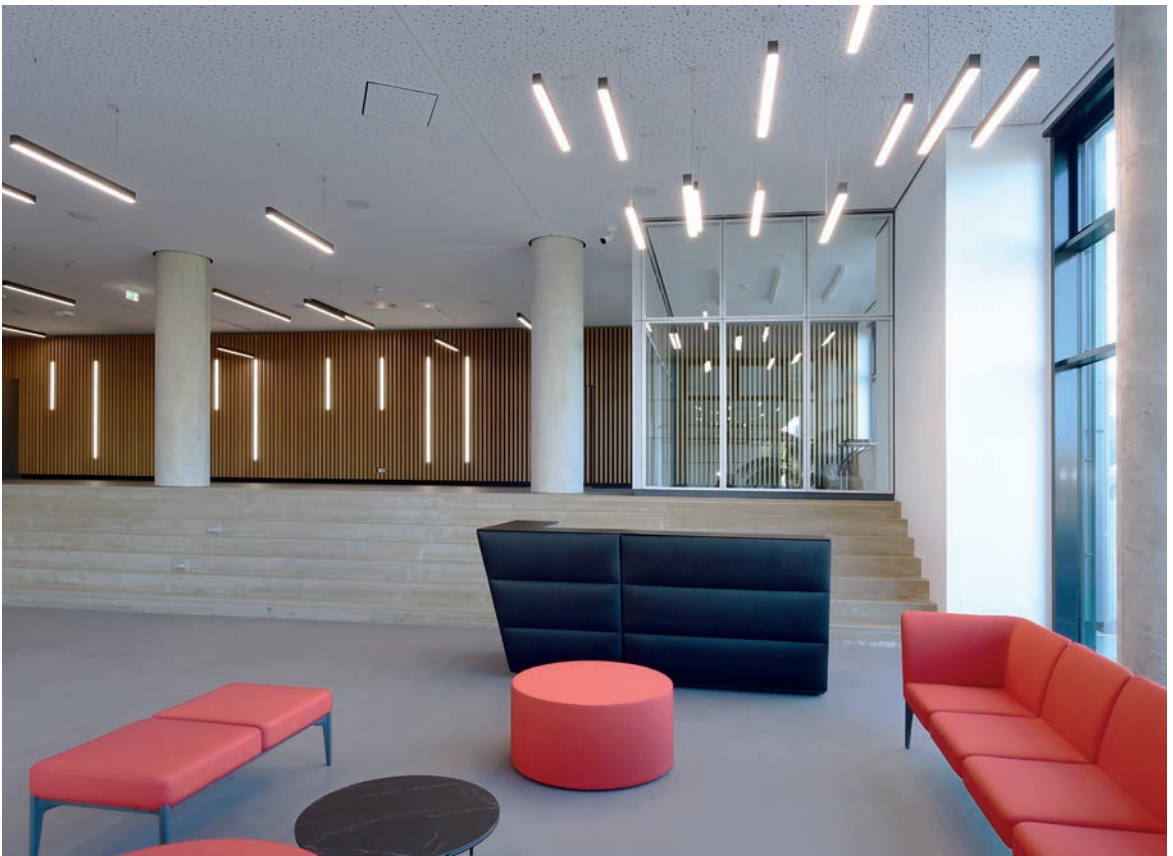



## COB SAUNA | 1CH | 24V

Our COB-SAUNA 24V LED stripes are the perfect lighting solution for saunas and steam baths. With an impressive lifetime of up to 75,000 hours for L70B50 and 50,000 hours for L80B10, these LED stripes offer a long-term lighting solution for your needs. In addition, the LED strip has an extra-long supply cable to provide you with maximum flexibility during installation. Item numbers 840409 and 840411 offer a 1.8 metre primary feed, while item numbers 840410 and 840412 offer both a 1.8 metre primary and secondary feed. The LED strip is permanently temperature resistant up to 105°C and has been developed especially for use in saunas and steam baths. Enjoy reliable lighting that withstands extreme temperatures while creating a pleasant atmosphere. As we have set ourselves the goal of becoming climate-neutral, the COB sauna LED stripes are packaged in an environmentally friendly paper-based way.

Important note regarding installation: It is not permitted to install the COB Sauna LEDStripes on aluminium or metal profiles! Installation is only permitted with the plastic profiles and silicone clips listed in the accessories!





# COB-SAUNA-24V

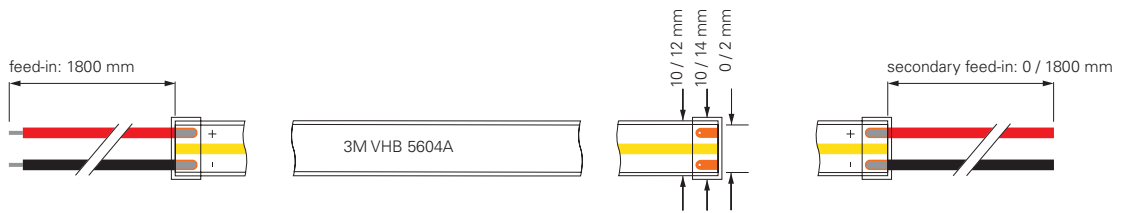
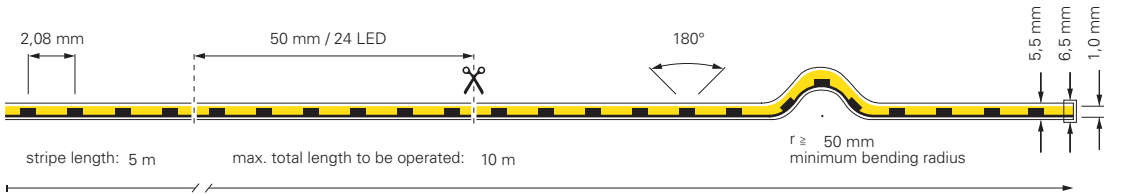

item	colour	temperature	efficiency	light current	dimensions L	power	light source	price
840409	ww	2700K	85 lm/W	850 lm/m	2000 mm	10 W/m	480 LED/m	99,95 €
840411	ww	2700K	85 lm/W	850 lm/m	5000 mm	10 W/m	480 LED/m	224,95 €
840410	ww	3000K	90 lm/W	900 lm/m	2000 mm	10 W/m	480 LED/m	99,95 €
840412	ww	3000K	90 lm/W	900 lm/m	5000 mm	10 W/m	480 LED/m	224,95 €

CV    24 Volt    COB    Ra 90    1 CH    IP67    -10°C / +105°C    A ↑ G    G



930736	silicone end caps set 2 pieces	0,95 €
930737	feed-in cable	12,95 €
930738	connector	17,95 €
930739	silicone clamps	1,95 €
930740	plastic profile 100cm	4,95 €
930741	plastic profile 200cm	9,95 €



## 2835-140-48V-2700K/3000K/4000K

**NEW**

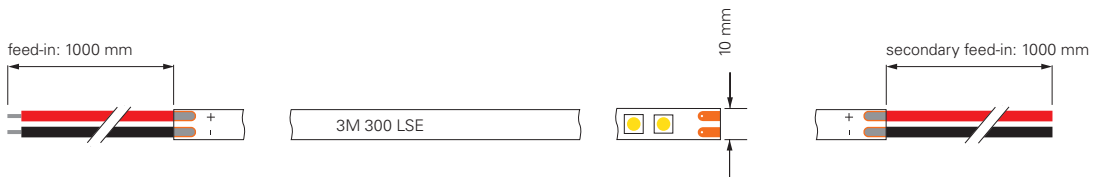
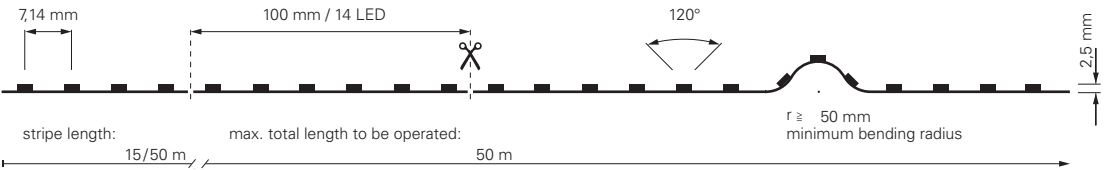

item	colour	temperature	efficiency	light current	dimensions L	power	light source	EEL	price
840393	ww	2700K	121 lm/W	1210 lm/m	15000 mm	10 W/m	140 LED/m	D	<b>399,95 €</b>
840401	ww	2700K	121 lm/W	1210 lm/m	50000 mm	10 W/m	140 LED/m	D	<b>1.299,95 €</b>
840394	ww	3000K	124 lm/W	1240 lm/m	15000 mm	10 W/m	140 LED/m	F	<b>399,95 €</b>
840402	ww	3000K	124 lm/W	1240 lm/m	50000 mm	10 W/m	140 LED/m	F	<b>1.299,95 €</b>
840395	nw	4000K	130 lm/W	1300 lm/m	15000 mm	10 W/m	140 LED/m	E	<b>399,95 €</b>
840403	nw	4000K	130 lm/W	1300 lm/m	50000 mm	10 W/m	140 LED/m	E	<b>1.299,95 €</b>





## 2835-140-48V-2700K/3000K/4000K-SILIKON

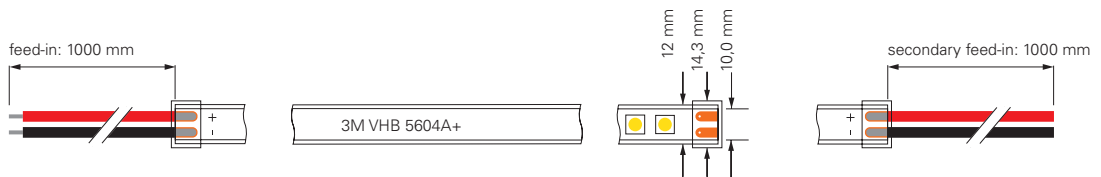
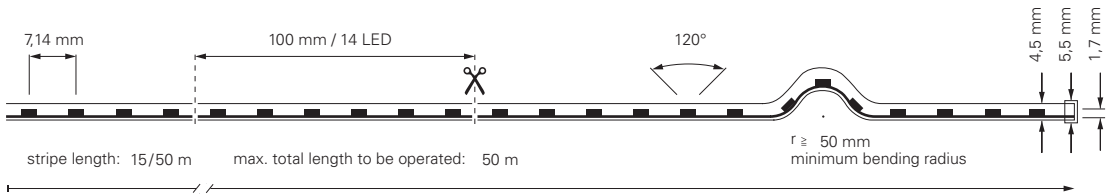

item	colour temperature	efficiency	light current	dimensions L	power	light source	EEL	price
<b>840396</b>	ww 2700K	109 lm/W	1090 lm/m	15000 mm	10 W/m	140 LED/m	D	<b>474,95 €</b>
<b>840404</b>	ww 2700K	109 lm/W	1090 lm/m	50000 mm	10 W/m	140 LED/m	D	<b>1.549,95 €</b>
<b>840397</b>	ww 3000K	112 lm/W	1120 lm/m	15000 mm	10 W/m	140 LED/m	F	<b>474,95 €</b>
<b>840405</b>	ww 3000K	112 lm/W	1120 lm/m	50000 mm	10 W/m	140 LED/m	F	<b>1.549,95 €</b>
<b>840398</b>	nw 4000K	118 lm/W	1180 lm/m	15000 mm	10 W/m	140 LED/m	F	<b>474,95 €</b>
<b>840406</b>	nw 4000K	118 lm/W	1180 lm/m	50000 mm	10 W/m	140 LED/m	F	<b>1.549,95 €</b>





## STANDARD | 3CH | 48V

Our new LED stripes in 48V technology offer users numerous advantages. The key advantage: Compared to 12V and 24V stripes, 48V stripes allow longer running lengths. By comparison, conventional LED stripes with lower output voltage require a new feed after only 2.5 metres [single-sided feed] or 5 metres [feed from both sides], for continuous operation. LED stripes with 48V can be used up to a length of 25 metres [single-sided feed] or feed) or 50 metres [feed on both sides] - perfect for lighting covers, long corridors and simplified integration into existing installations, that only allow a single-sided feed.

### Advantages of 48V LED stripes

- 48V = lower current
- 48V = longer running length
- 48V = thinner wire cross-sections
- 48V = faster installation
- 48V = more versatile applications
- 48V = lower brightness drop

In addition to the advantages mentioned above, our new 48V LED stripes have a very long service life of up to 75,000h for L70B50 and 50,000h for L80B10. Thanks to reel-to-reel production, the 48V LED stripes have no soldered joints. As we have set ourselves the goal to become climate-neutral, the LED stripes are packaged in an environmentally friendly paper-based packaging.

In addition to the new 48V LED stripes, we of course also offer accessories in the form of power supply units and controllers for the relevant control protocols [RF, DALI, KNX etc.] in order to cover all potential future applications for 48V stripes.



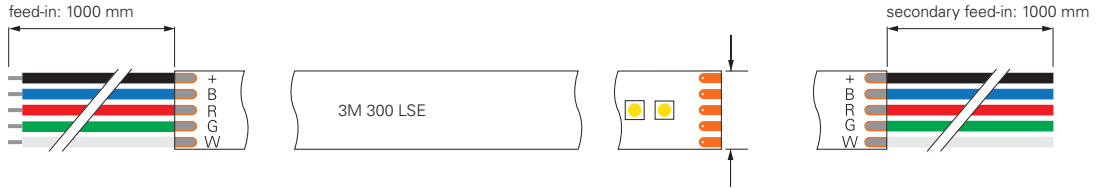
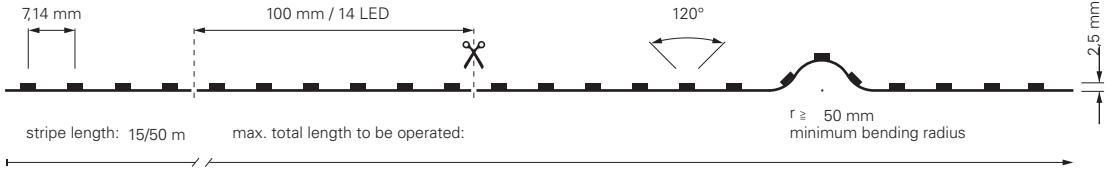

item	colour	temperature	efficiency	light current	dimensions L	power	light source	price
<b>840399</b>	RGB	450-630 nm	51 lm/W	510 lm/m	15000 mm	10 W/m	140 LED/m	<b>449,95 €</b>
<b>840407</b>	RGB	450-630 nm	51 lm/W	510 lm/m	50000 mm	10 W/m	140 LED/m	<b>1.499,95 €</b>

CV

48 Volt

SMD 3535

3 CH

IP20

-10°C  
+55°C

### 3535-140-48V-RGB-SILIKON

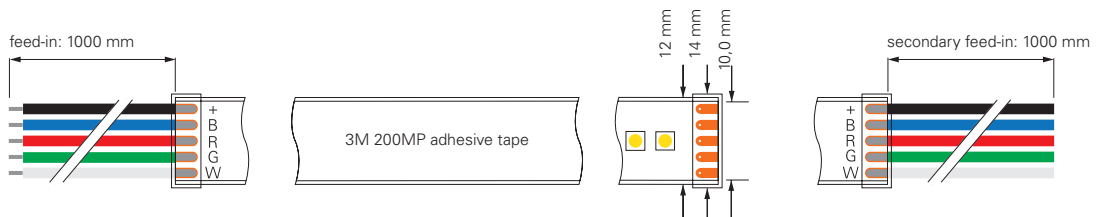
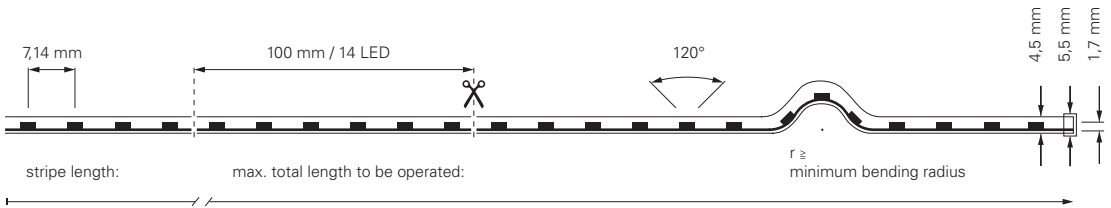

item	colour	temperature	efficiency	light current	dimensions L	power	light source	price
<b>840400</b>	RGB	450-630 nm	45 lm/W	450 lm/m	15000 mm	10 W/m	140 LED/m	<b>524,95 €</b>
<b>840408</b>	RGB	450-630 nm	45 lm/W	450 lm/m	50000 mm	10 W/m	140 LED/m	<b>1.749,95 €</b>

CV

48 Volt

SMD 3535

3 CH

IP67

-10°C  
+55°C

## POWER SUPPLIES

DC | CV  
not dimmable

### DEKO-LIGHT POWER SUPPLIES | DESIGN FLAT

- plastic housing
- suitable for indoor use
- ideal for concealed mounting in ceiling coving
- flicker free
- short-circuit proof and overload protection
- overheat control



design example

item	colour	voltage	power	electricity	max. inrush current	dimensions L x W x H	price
<b>872629</b>	■ black	12V	6W	0-500mA	7A/300µs	98 x 46 x 11 mm	<b>16,95 €</b>
<b>862231</b>	■ black	12V	12W	0-1000mA	15A/200µs	128 x 50 x 13 mm	<b>21,95 €</b> <b>NEW</b>
<b>862232</b>	■ black	12V	20W	0-1670mA	20A/100µs	128 x 50 x 13 mm	<b>25,95 €</b>
<b>862121</b>	■ black	12V	50W	0-4160mA	15A/300µs	185 x 62 x 22 mm	<b>52,95 €</b>
<b>872630</b>	■ black	24V	6W	0-250mA	7A/300µs	98 x 46 x 11 mm	<b>16,95 €</b>
<b>862233</b>	■ black	24V	12W	0-500mA	15A/200µs	128 x 50 x 13 mm	<b>21,95 €</b>
<b>862234</b>	■ black	24V	20W	0-830mA	20A/100µs	128 x 50 x 13 mm	<b>25,95 €</b>
<b>862122</b>	■ black	24V	50W	0-2100mA	15A/300µs	185 x 62 x 22 mm	<b>52,95 €</b>



### DEKO-LIGHT POWER SUPPLIES | DESIGN LONG-FLAT

design example

- plastic housing
- suitable for indoor use
- ideal for concealed mounting in ceiling coving
- flicker free
- short-circuit proof and overload protection
- overheat control

item	colour	voltage	power	electricity	max. inrush current	dimensions L x W x H	price
<b>862123</b>	■ black	12V	45W	0-3750mA	30A/300µs	251 x 30 x 16 mm	<b>49,95 €</b>
<b>862093</b>	□ white	12V	60W	0-5000mA	30A/300µs	305 x 30 x 17 mm	<b>59,95 €</b>
<b>862125</b>	■ black	12V	100W	0-8340mA	50A/300µs	312 x 30 x 18 mm	<b>96,95 €</b>
<b>862172</b>	■ black	12V	150W	0-12500mA	60A/300µs	335 x 30 x 22 mm	<b>129,95 €</b>
<b>862124</b>	■ black	24V	45W	0-1870mA	30A/300µs	251 x 30 x 16 mm	<b>49,95 €</b>
<b>862094</b>	■ black	24V	60W	0-2500mA	30A/300µs	305 x 30 x 17 mm	<b>59,95 €</b>
<b>862126</b>	■ black	24V	100W	0-4170mA	50A/300µs	312 x 30 x 18 mm	<b>96,95 €</b>
<b>862173</b>	■ black	24V	150W	0-6250mA	60A/300µs	335 x 30 x 22 mm	<b>129,95 €</b>
<b>862265</b>	■ black	24V	240W	0-10000mA	120A/500µs	357 x 32 x 23 mm	<b>159,95 €</b> <b>NEW</b>



## POWER SUPPLIES

DC | CV  
dimnable

### DEKO-LIGHT POWER SUPPLIES | DESIGN IP PRIMARY DIMMABLE

- metal housing
- suitable for indoor and outdoor use
- ideal for upgrade existing installations, as primarily with commercially available rotary / touch dimmers [C-capable, via phase angle or section] dimmable
- cannot be combined with PWM dimmers such as RF, DMX, DALI or KNX
- flicker free
- short-circuit proof and overload protection
- overheat control



design example

item	colour	voltage	power	max. inrush current	dimensions L x W x H	price
<b>872135</b>	<input type="checkbox"/> silver coloured	12V	33 - 100W	45A/100µs	191 x 70 x 40 mm	<b>169,95 €</b>
<b>872137</b>	<input type="checkbox"/> silver coloured	12V	66 - 200W	45A/100µs	249 x 72 x 40 mm	<b>206,95 €</b>
<b>872136</b>	<input type="checkbox"/> silver coloured	24V	33 - 100W	45A/100µs	191 x 70 x 40 mm	<b>169,95 €</b>
<b>872138</b>	<input type="checkbox"/> silver coloured	24V	66 - 200W	45A/100µs	249 x 72 x 40 mm	<b>206,95 €</b>
<b>872142</b>	<input type="checkbox"/> silver coloured	48V	33 - 100W	45A/100µs	191 x 70 x 40 mm	<b>169,95 €</b> <b>NEW</b>
<b>872143</b>	<input type="checkbox"/> silver coloured	48V	66 - 200W	45A/100µs	249 x 72 x 40 mm	<b>206,95 €</b> <b>NEW</b>





## POWER SUPPLIES

DC | CV  
dimmable



### DEKO-LIGHT POWER SUPPLIES LCP DALI

- plastic housing
- suitable for indoor use
- short-circuit proof and overload protection
- overheat control
- dimmable via DALI2 or DALI1, 10V / 1-10V or Touch-Dim via 230V Taster
- new Intelli-Push function [key combination synchronises all connected power supplies]



design example

item	colour	voltage	power	electricity	max. inrush current	dimensions L x W x H	price
<b>862253</b>	white	12V	40W	0-3400mA	10A/32µs	185 x 42,5 x 28,5 mm	<b>99,95 €</b>
<b>862254</b>	white	12V	75W	0-6250mA	22A/300µs	295 x 40 x 32 mm	<b>129,95 €</b>
<b>862255</b>	white	24V	40W	0-1700mA	10A/32µs	185 x 42,5 x 28,5 mm	<b>99,95 €</b>
<b>862256</b>	white	24V	75W	0-3125mA	22A/300µs	295 x 40 x 32 mm	<b>129,95 €</b>
<b>862262</b>	white	24V	150W	0-6250mA	38A/430µs	295 x 40 x 32 mm	<b>169,95 €</b> <b>NEW</b>
<b>862263</b>	white	24V	240W	0-10000mA	60A/430µs	360 x 40 x 32 mm	<b>219,95 €</b> <b>NEW</b>



## POWER SUPPLIES

DC | CC  
not dimmable



design example

### DEKO-LIGHT POWER SUPPLIES | DESIGN FLAT

- plastic housing
- suitable for indoor use
- flicker free
- short-circuit proof and overload protection

item	colour	electricity	power	voltage	max. inrush current	dimensions L x W x H	price
<b>872628</b>	black	350mA	0,70-6,00W	2-18V	10A/300µs	98 x 46 x 11 mm	<b>17,95 €</b>
<b>862223</b>	black	350mA	0,70-12,00W	2-35V	10A/100µs	128 x 50 x 13 mm	<b>24,95 €</b>
<b>862224</b>	black	350mA	0,70-20,00W	2-57V	10A/100µs	154 x 50 x 14 mm	<b>28,95 €</b> <b>NEW</b>
<b>862130</b>	black	500mA	1,00-6,00W	2-12V	10A/300µs	98 x 46 x 11 mm	<b>17,95 €</b>
<b>862225</b>	black	500mA	1,00-12,00W	2-24V	10A/100µs	128 x 50 x 13 mm	<b>24,95 €</b>
<b>862226</b>	black	500mA	1,00-20,00W	2-40V	10A/100µs	154 x 50 x 14 mm	<b>28,95 €</b> <b>NEW</b>
<b>862048</b>	black	700mA	1,40-6,00W	2-9V	10A/300µs	98 x 46 x 11 mm	<b>17,95 €</b>
<b>862227</b>	black	700mA	1,40-12,00W	2-17V	10A/100µs	128 x 50 x 14 mm	<b>24,95 €</b> <b>NEW</b>
<b>862228</b>	black	700mA	1,40-20,00W	2-29V	10A/100µs	128 x 50 x 14 mm	<b>28,95 €</b> <b>NEW</b>



## POWER SUPPLIES

DC | CC  
dimnable

### DEKO-LIGHT POWER SUPPLIES | DESIGN BASIC

- plastic housing
- suitable for indoor use
- short-circuit proof and overload protection
- overheat control
- dimmable with compatible [C-capable] phase cut-off dimmers



design example

item	colour	electricity	power	voltage	max. inrush current	dimensions L x W x H	price
<b>862202</b>	■ black	350mA	3,90-9,00W	11- 26V	10A/300µs	115 x 39 x 22 mm	<b>28,95 €</b>
<b>862203</b>	■ black	350mA	6,30-12,00W	18-35V	10A/300µs	115 x 39 x 22 mm	<b>36,95 €</b>
<b>862204</b>	■ black	350mA	9,80-20,00W	28,57V	15A/300µs	127 x 44 x 28 mm	<b>39,95 €</b>
<b>862205</b>	■ black	500mA	10,00-20,00W	20-40V	15A/300µs	127 x 44 x 28 mm	<b>39,95 €</b>
<b>862136</b>	■ black	500mA	20,00-40,00W	40-80V	5A/300µs	166 x 52 x 24 mm	<b>46,95 €</b>
<b>862207</b>	■ black	700mA	9,80-20,00W	14-28V	15A/300µs	127 x 44 x 28 mm	<b>39,95 €</b>
<b>862208</b>	■ black	700mA	19,60-40,00W	28-56V	5A/300µs	166 x 52 x 24 mm	<b>46,95 €</b>
<b>862264</b>	■ black	900mA	19,60-40,00W	22-44V	5A/100µs	166 x 52 x 25 mm	<b>46,95 €</b> <b>NEW</b>
<b>872647</b>	■ black	1050mA	9,80-22,00W	9-20V	15A/300µs	127 x 44 x 28 mm	<b>39,95 €</b>
<b>862209</b>	■ black	1050mA	20,00-40,00W	19-38V	5A/300µs	166 x 52 x 25 mm	<b>46,95 €</b>
<b>862210</b>	■ black	1050mA	23,50-45,00W	22-43V	5A/100µs	166 x 52 x 25 mm	<b>49,95 €</b>
<b>862211</b>	■ black	1300mA	26,00-50,00W	20-39V	5A/300µs	166 x 52 x 25 mm	<b>51,95 €</b>
<b>862138</b>	■ black	1400mA	19,60-40,00W	14-28V	5A/300µs	166 x 52 x 24 mm	<b>46,95 €</b>



## DEKO-LIGHT RF-SMART

We are pleased to introduce you to the new multifunctional RF-smart control system from DEKO-LIGHT. In addition to controlling and dimming devices with 230V mains voltage, LED dimmers for controlling LED strips with 1-5 channels [single/CCT/RGB/RGBW/RGBW+CCT] and a voltage of 12V to 48V are available. For outdoor use, you will also find dimmers in IP67 version. The system is perfectly complemented by matching luminaires with integrated RF module, such as outdoor floodlights, an outdoor spotlight with a particularly narrow beam angle and LED retrofit bulbs for common bulb sockets.

In the most basic configuration level, you control RF-smart components with the corresponding RF radio remote controls. Here, not only are starter remote controls available with functions and a control zone, but also battery-operated wall-mounted remote controls with up to eight individually controllable zones are available. This selection already offers you and your customers a multitude of possibilities.

The integrated RF autosync function for important functions - such as the range extension of RF remote controls or the synchronisation of running automatic programmes when using several dimmers - obviates the need for additional installation work and costs.

But there is more: most RF-smart components are also equipped with a Zigbee 3.0-compatible radio module that can be used to realise a wide range of smart home functions [compatible with the most important smart home systems, including Amazon Echo [Alexa], Google Assistant, Tuya and more]. In this way, you are free to choose whether to control the connected RF-smart components via smartphone, tablet and/or your voice. The Zigbee 3.0 radio standard offers comprehensive compatibility with a wide range of apps from different providers for an almost limitless variety of applications. Speaking of limitless: thanks to controlling via app and respective functions, you can control connected RF-smart luminaires worldwide without installing additional components!

Thanks to sophisticated technology, installation and initial commissioning are extremely simple. Directly after the electrical connection, all necessary function tests of the connected luminaires or devices can be carried out. The two dimmer modules are seamlessly complemented by integrated push inputs. With these isolated push-button inputs, you can in most cases use an existing electrical installation, including the existing switch system, to switch the connected RF-smart dimmers on/off and, if necessary, dim them using standard push-buttons.

RF-smart represents a simple, super-fast installation and commissioning and at the same time offers a maximum of convenience in controlling.





## DEKO-LIGHT RF-SMART STARTER-SET 1 230V TRIAC DIMMER + RF-REMOTE CONTROL

- set consisting of:  
1x TRIAC DIMMER 230V [843503]  
1x RF-REMOTE CONTROL Single/CCT white [843508]
- operation with 2x AAA batteries [not included in delivery]
- for technical data see item codes mentioned above

item	colour	controlling of	price
<b>843500</b>	■ □ black + white	230V components	<b>99,95 €</b>



## DEKO-LIGHT RF-SMART STARTER-SET 2 LED DIMMER + RF-REMOTE CONTROL SINGLE/CCT

- set consisting of:  
1x LED DIMMER 5-IN-1 [843505]  
1x RF-REMOTE CONTROL Single/CCT white [843508]
- operation with 2x AAA batteries [not included in delivery]
- for technical data see item codes mentioned above

item	colour	controlling of	price
<b>843501</b>	■ □ black + white	Single/CCT	<b>99,95 €</b>



## DEKO-LIGHT RF-SMART STARTER-SET 3 LED DIMMER + RF-REMOTE CONTROL RGB/RGBW/RGB+CCT

- set consisting of:  
1x LED DIMMER 5-IN-1 [843505]  
1x RF-REMOTE CONTROL Single/CCT white [843510]
- operation with 2x AAA batteries [not included in delivery]
- for technical data see item codes mentioned above

item	colour	controlling of	price
<b>843502</b>	■ □ black + white	RGB/RGBW/RGB+CCT	<b>99,95 €</b>







## DEKO-LIGHT RF-SMART TRIAC DIMMER 230V

- plastic
- Last-State-Memory [last setting is stored]
- adjustable function mode [dimmer or on/off switch]
- adjustment function for minimum brightness
- Push-Dim connection [push-button for on/off + brightness]
- Intelli-Push function
- remote control synchronisation when operating several RF-smart dimmers [repeater function]
- controllable with RF-smart radio remote control [2.4GHz, range approx. 30m, not included]
- controllable with all Zigbee 3.0 compatible controllers / apps e.g. Amazon Echo [Alexa], Google Assistant, Tuya [corresponding gateway required, outdoor range up to 100m]
- controller dimensions L x W x H: 25 x 49 x 49 mm
- power: max. 300W / 1,36A



item	colour	controlling of	price
<b>843503</b>	■ black	230V components	<b>69,95 €</b>



## DEKO-LIGHT RF-SMART OUTDOOR TRIAC DIMMER 230V

- plastic
- Last-State-Memory [last setting is stored]
- adjustable function mode [dimmer or on/off switch]
- adjustment function for minimum brightness
- remote control synchronisation when operating several RF-smart dimmers [repeater function]
- controllable with RF-smart radio remote control [2.4GHz, range approx. 30m, not included]
- controllable with all Zigbee 3.0 compatible controllers / apps e.g. Amazon Echo [Alexa], Google Assistant, Tuya [corresponding gateway required, outdoor range up to 100m]
- controller dimensions L x W x H: 170 x 155 x 65 mm
- power: max. 300W / 1,36A
- outdoor installation distributor IP67 with up to 4 cable entries from 4-14mm as well as 2 blind plugs



item	colour	controlling of	price
<b>843504</b>	■ black	230V components	<b>89,95 €</b>



## DEKO-LIGHT RF-SMART LED DIMMER 5-IN-1, 5 CHANNEL SINGLE/CCT/RGB/RGBW/RGB+CCT

- plastic
- 16 million colours and colour temperature adjustable [depending on the selected channel mode]
- 8 automatic programmes pre-installed
- programme speed adjustable via remote control
- flicker-free [picture/video recordings]
- Last-State-Memory [last setting is stored]
- Push-Dim connection [push-button for on/off + brightness]
- Intelli-Push function
- programme and remote control synchronisation when operating several several RF-smart dimmers [master/slave and repeater function]
- controllable with RF-smart radio remote control [2.4GHz, range approx. 30m, not included]
- controllable with all Zigbee 3.0 compatible controllers / apps e.g. Amazon Echo [Alexa], Google Assistant, Tuya [corresponding gateway required, outdoor range up to 100m]
- controller dimensions L x W x H: 23 x 47 x 120 mm
- power: max. 20A/controller, max. 10A/channel
- 12V= 240W, 24V= 480W, 48V= 960W



item	colour	controlling of	price
<b>843505</b>	■ black	Single/CCT /RGB/RGBW/RGB+CCT	<b>69,95 €</b>



## DEKO-LIGHT RF-SMART OUTDOOR LED DIMMER 5-IN-1, 5 CHANNEL SINGLE/CCT/RGB/RGBW/RGB+CCT

- plastic
- 16 million colours and colour temperature adjustable [depending on the selected channel mode]
- 8 automatic programmes pre-installed
- programme speed adjustable via remote control
- flicker-free [picture/video recordings]
- Last-State-Memory [last setting is stored]
- programme and remote control synchronisation when operating several several RF-smart dimmers [master/slave and repeater function]
- controllable with RF-smart radio remote control [2.4GHz, range approx. 30m, not included]
- controllable with all Zigbee 3.0 compatible controllers / apps e.g. Amazon Echo [Alexa], Google Assistant, Tuya [corresponding gateway required, outdoor range up to 100m]
- controller dimensions L x W x H: 30 x 88 x 200 mm
- power: max. 20A/controller, max. 10A/channel
- 12V= 240W, 24V= 480W, 48V= 960W
- 20 cm connection cable pre-assembled



item	colour	controlling of	price
<b>843506</b>	■ black	Single/CCT /RGB/RGBW/RGB+CCT	<b>109,95 €</b>





## DEKO-LIGHT RF-SMART RF-REPEATER

- plastic
- extends the range of an RF remote control by approx. 30m
- supports remote control and programme synchronisation when operating several RF-smart components [repeater function]
- supports up to 12 RF remote controls
- also suitable for outdoor use
- incl. 1m connection cable with IP44 plug
- controller dimensions L x W x H: 103 x 34 x 34 mm

item	colour	price
<b>843507</b>	<input type="checkbox"/> white	<b>34,95 €</b>



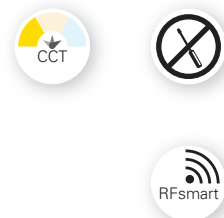

## DEKO-LIGHT RF-SMART RF-REMOTE CONTROL SINGLE/CCT

- plastic
- hand-held remote control
- incl. magnetic holder for additional wall mounting
- dimensions L x Ø: 24 x 70 mm
- brightness dimmable
- colour temperature adjustable if necessary
- RF radio remote control [2.4GHz, range approx. 30m]
- battery operation 3V [2x AAA not included in delivery]

item	colour	controlling of	differently controllable zones	price
<b>843508</b>	<input type="checkbox"/> white	Single/CCT	1	<b>38,95 €</b>
<b>843509</b>	<input checked="" type="checkbox"/> black	Single/CCT	1	<b>38,95 €</b>

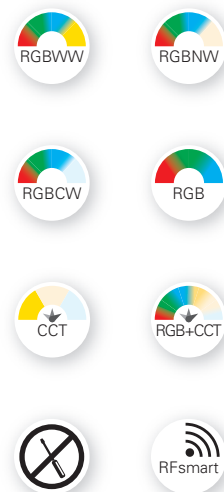

## DEKO-LIGHT RF-SMART RF-REMOTE CONTROL RGB/RGBW/RGB+CCT

- plastic
- hand-held remote control
- incl. magnetic holder for additional wall mounting
- dimensions L x Ø: 24 x 70 mm
- brightness dimmable
- colours and, if necessary, saturation and colour temperature adjustable
- automatic programmes selectable
- colour temperature adjustable if necessary
- RF radio remote control [2.4GHz, range approx. 30m]
- battery operation 3V [2x AAA not included in delivery]

item	colour	controlling of	differently controllable zones	price
<b>843510</b>	<input type="checkbox"/> white	RGB/RGBW/RGB+CCT	1	<b>38,95 €</b>
<b>843511</b>	<input checked="" type="checkbox"/> black	RGB/RGBW/RGB+CCT	1	<b>38,95 €</b>





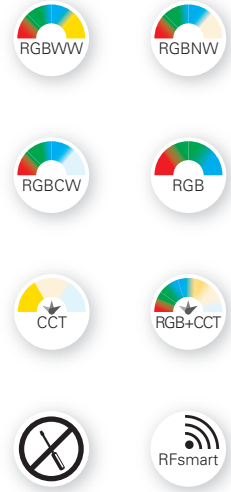

**DEKO-LIGHT RF-SMART  
RF-REMOTE CONTROL 8 ZONES  
SINGLE/CCT/RGB/RGBW/RGB+CCT**

- plastic
- hand-held remote control
- dimensions L x W x H: 19 x 153 x 47 mm
- brightness, if necessary, colours, saturation, colour temperature adjustable
- automatic programmes and speed selectable
- RF-smart dimmer and/or luminaires can be divided into up to 8 differently controllable zones
- RF radio remote control [2.4GHz, range approx. 30m]
- battery operation 3V [2x AAA not included in delivery]
- incl. wall mounting bracket

item	colour	controlling of	differently controllable zones	price
<b>843512</b>	■ black	Single/CCT/RGB/RGBW/RGB+CCT	up to 8	<b>49,95 €</b>





## DEKO-LIGHT RF-SMART RF-WALL REMOTE CONTROL 4 ZONES SINGLE/CCT/RGB/RGBW/RGB+CCT

- plastic
- wall remote control [surface-mounted]
- dimensions L x W x H: 16 x 86 x 86 mm
- brightness, if necessary, colours, saturation, colour temperature adjustable
- automatic programmes and speed selectable
- RF-smart dimmer and/or luminaires can be divided into up to 4 differently controllable zones
- RF radio remote control [2.4GHz, range approx. 30m]
- battery operation 3V [2x AAA not included in delivery]

item	colour	controlling of	differently controllable zones	price
<b>843513</b>	<input type="checkbox"/> white	Single/CCT/RGB/RGBW/RGB+CCT	up to 4	<b>69,95 €</b>



## DEKO-LIGHT RF-SMART RF-WALL REMOTE CONTROL 8 ZONES SINGLE/CCT/RGB/RGBW/RGB+CCT

- plastic
- wall remote control [surface-mounted]
- dimensions L x W x H: 20 x 106 x 146 mm
- brightness, if necessary, colours, saturation, colour temperature adjustable
- automatic programmes and speed selectable
- RF-smart dimmer and/or luminaires can be divided into up to 8 differently controllable zones
- delayed auto-off function with 60s time delay
- RF radio remote control [2.4GHz, range approx. 30m]
- battery operation 3V [2x AAA not included in delivery]

item	colour	controlling of	differently controllable zones	price
<b>843514</b>	<input type="checkbox"/> white	Single/CCT/RGB/RGBW/RGB+CCT	up to 8	<b>109,95 €</b>





## DEKO-LIGHT RF-SMART ILLUMINANT GU10 RGB+CCT RF CONTROLLABLE

- plastic
- dimensions L x Ø: 57 x 50 mm
- brightness and colour saturation dimmable
- 16 million colours and colour temperature adjustable
- 18 automatic programmes preinstalled
- programme and remote control synchronisation when operating several RF-smart lamps [repeater function]
- controllable with RF-smart radio remote controls [2.4GHz, range approx. 30m, not included in delivery]
- controllable with RF remote control only [no Zigbee functionality]

item	colour	colour temp.	light current	power	equivalent to	EEL energy consumption	price
<b>843515</b>	<input type="checkbox"/> white	<b>RGB</b> <b>WW</b> <b>CW</b> 2700-6000 K	300 lm	4 W	35 W	F 4 kWh/1000h	<b>34,95 €</b>





## DEKO-LIGHT RF-SMART ILLUMINANT E27 A60 RGB+CCT RF CONTROLLABLE

- plastic
- dimensions L x Ø: 100 x 57 mm
- brightness and colour saturation dimmable
- 16 million colours and colour temperature adjustable
- 18 automatic programmes preinstalled
- programme and remote control synchronisation when operating several RF-smart lamps [repeater function]
- controllable with RF-smart radio remote controls [2.4GHz, range approx. 30m, not included in delivery]
- controllable with RF remote control only [no Zigbee functionality]

item	colour	colour temp.	light current	power	equivalent to	beam angle	EEL energy consumption	price
<b>843516</b>	<input type="checkbox"/> white	<input type="checkbox"/> RGB <input type="checkbox"/> WW <input type="checkbox"/> CW 2700-6000 K	550 lm	6 W	55 W	220°	F 6 kWh/1000h	<b>34,95 €</b>



## DEKO-LIGHT RF-SMART ILLUMINANT E27 MAX RGB+CCT RF CONTROLLABLE

- plastic
- dimensions L x Ø: 140 x 74 mm
- brightness and colour saturation dimmable
- 16 million colours and colour temperature adjustable
- 18 automatic programmes preinstalled
- programme and remote control synchronisation when operating several RF-smart lamps [repeater function]
- controllable with RF-smart radio remote controls [2.4GHz, range approx. 30m, not included in delivery]
- controllable with RF remote control only [no Zigbee functionality]

item	colour	colour temp.	light current	power	equivalent to	beam angle	EEL energy consumption	price
<b>843517</b>	<input type="checkbox"/> white	<input type="checkbox"/> RGB <input type="checkbox"/> WW <input type="checkbox"/> CW 2700-6000 K	1100 lm	12 W	100 W	220°	F 12 kWh/1000h	<b>64,95 €</b>







## DEKO-LIGHT RF-SMART FLOOD RGB+CCT RF + ZIGBEE

- aluminium diecast / plastic
- brightness and colour saturation dimmable
- 16 million colours and colour temperature adjustable
- 18 automatic programmes preinstalled
- programme and remote control synchronisation when operating several RF-smart lamps [repeater function]
- controllable with RF-smart radio remote controls [2.4GHz, range approx. 30m, not included in delivery]
- controllable with all Zigbee 3.0 compatible controllers / apps such as Amazon Echo [Alexa], Google Assistant, Tuya [corresponding gateway required, outdoor range up to 100m]
- incl. 1.5 m connection cable with IP44 plug

item	colour	colour temp.	light current	power	dimensions L x W x H	EEL	price
<b>843518</b>	■ anthracite	2700-6000 K	3300 lm	30 W	167 x 40 x 227 mm	E	<b>249,95 €</b>
<b>843519</b>	■ anthracite	2700-6000 K	4800 lm	50 W	220 x 48 x 311 mm	F	<b>349,95 €</b>
<b>843520</b>	■ anthracite	2700-6000 K	10000 lm	100 W	295 x 60 x 403 mm	F	<b>549,95 €</b>



accessories

**930659** wall bracket / display arm | black **59,95 €**



With the kind support of Loxone Lichtinstallation Eurotec-Ibiza@fotoeichhorn



## DEKO-LIGHT RF-SMART SPOT RGB+CCT RF + ZIGBEE

- aluminium diecast / plastic
- brightness and colour saturation dimmable
- 16 million colours and colour temperature adjustable
- 18 automatic programmes preinstalled
- programme and remote control synchronisation when operating several RF-smart lamps [repeater function]
- controllable with RF-smart radio remote controls [2.4GHz, range approx. 30m, not included in delivery]
- controllable with all Zigbee 3.0 compatible controllers / apps such as Amazon Echo [Alexa], Google Assistant, Tuya [corresponding gateway required, outdoor range up to 100m]
- incl. 1.5 m connection cable with IP44 plug
- incl. ground spike
- very narrow beam angle, ideal for column lighting or similar

item	colour	colour temp.	light current	power	dimensions L x W x H	price
<b>843521</b>	■ anthracite	2700-6000 K	1700 lm	25 W	170 x 65 x 180 mm	<b>239,95 €</b>



accessories

**930659** wall bracket / display arm | black **59,95 €**





## DEKO-LIGHT MULTI DIMMER 4 4 CHANNEL 3-IN-CONTROL / PWM DIMMER

- DMX control / mode
- automatic / program mode
- manual dimmer mode
- use as 1, 2, 3 or 4 channel dimmer
- 24 color change programs preset
- manual mode allows to dim the 4 channels on the fixture individually [manual color setting]
- flicker-free for video recording [2 kHz]
- master/slave function
- easy and user-friendly programming via 4-button control menu and display
- after power failure dimmer automatically shows last mode, program or colour setting
- DMX signal / master-slave pluggable via CAT5
- dimensions L x W x H: 116 x 57 x 26,8 mm
- max. 20A [4x 5A each channel]
- power: 4x 60W [240W] at 12V,  
4x 120W [480W] at 24V,  
4x 240W [960W] at 48V

item	colour	price
<b>843279</b>	 black	<b>114,95 €</b>



### accessories

<b>930697</b>	Data cable RJ45 for connecting controller or further dimmers, length 2.0 m	<b>3,95 €</b>
---------------	--	---------------



## DEKO-LIGHT DALI MULTI LED PWM-DIMMER 1-4 CHANNEL

Innovative and adjustable multi-LED Dali dimmer that can be set to the individually required number of channels [1-4] by means of DIP switches. The highlight of the dimmer exclusively available at DEKO-LIGHT: it occupies only the set number of channels in the Dali bus and thus saves a lot of otherwise unnecessarily occupied system resources. The dimmer is suitable for 12V-48V Stripes and with a frequency of 2 kHz flicker-free and therefore also for the event technology in theaters, Stutdi etc. best suited.

- for controlling 1-4 channel LED stripes [single, WW/CW, RGB, RGBW components]
- required channel mode can be set individually by DIP switch
- dimmer occupies only set number of DALI channels
- controllable/dimmable via DALI 1 or DALI 2
- Device Type DT6
- flicker free [2 2 kHz]
- overload / short circuit indication / switch-off
- dimensions L x W x H: 180 x 52 x 20 mm
- power: 20A [max. 4x5 A]  
4x 60W [240W] at 12V,  
4x 120W [480W] at 24V,  
4x 240W [960W] at 48V

item	colour	price
<b>843070</b>	<input type="checkbox"/> white	<b>134,95 €</b>

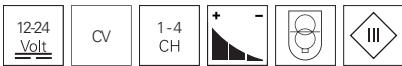

## DEKO-LIGHT DALI LED PWM-DIMMER 1/2 CHANNEL



- for controlling 1-2 channel LED stripes [single, WW/CW components]
- dimmable via Dali Bus according to IEC 62386
- overload / short circuit indication / switch-off
- dimensions L x W x H: 167 x 51 x 23 mm
- max. 5A each channel
- power: 2x 120W [240W] at 12 V,  
2x 240W [480W] at 24 V



item	colour	Typ	price
<b>843051</b>	<input type="checkbox"/> white	DT6 / 2 DALI addresses	<b>109,95 €</b>
<b>843071</b>	<input type="checkbox"/> white	DT8 / 1 DALI address	<b>109,95 €</b>







## ELECTRIC CHARACTERISTICS





 operating voltage range of product  
 alternative current [AC] / direct current [DC]



 constant voltage + operating voltage



 constant current + amperage

 flicker free



 power consumption

 solar panel

 USB charging socket

 battery operation



## LAMP



 LED technology:  
 chip on board + surface mounted device





 [Number] LED exchangeable

 changeable LED chips





 [Number] LED not exchangeable

 LED type and design



 base of lamp + halogen and LED applicable  
 [not included in delivery scope]



 base of lamp + halogen and LED applicable  
 [included in delivery scope]



 base of lamp + LED applicable  
 [included in delivery scope]

 average service life in hours

 power consumption











 light colour [colour temperature]



 colour display

## FUNCTIONALITY

 beam angle







 swivel-mounted +  
 double swivel-mounted +  
 rotatable and swivel-mounted + rotatable

 max. inclination angle



 radiation direction

## MOUNTING



 cutout dimension in mm

 mounting depth in mm

## SURFACE

 NANO coating IP XX [see product description]  
 lotus effect: Water rolls off and takes all dirty surface  
 particles with it.

 surface paintable /  
 individual design

## CONTROL



dim to warm function



radio frequency control



Bluetooth control



WiFi control



movement sensor [IR / HF]



DMX control



signal cable



dimmable



number of channels

## SAFETY



IP protection class



IK value



walkable



passable



safety lamp control gear



components may be installed on fixtures of materials,  
the fire behavior of which is not always known.



max. surface temperature  
of lamp control gear



protection class I



protection class II  
[protective isolation]



protection class III  
[protective low voltage]



no cool beam  
In lamps identified as such,  
no cold light mirror lamps may be installed.

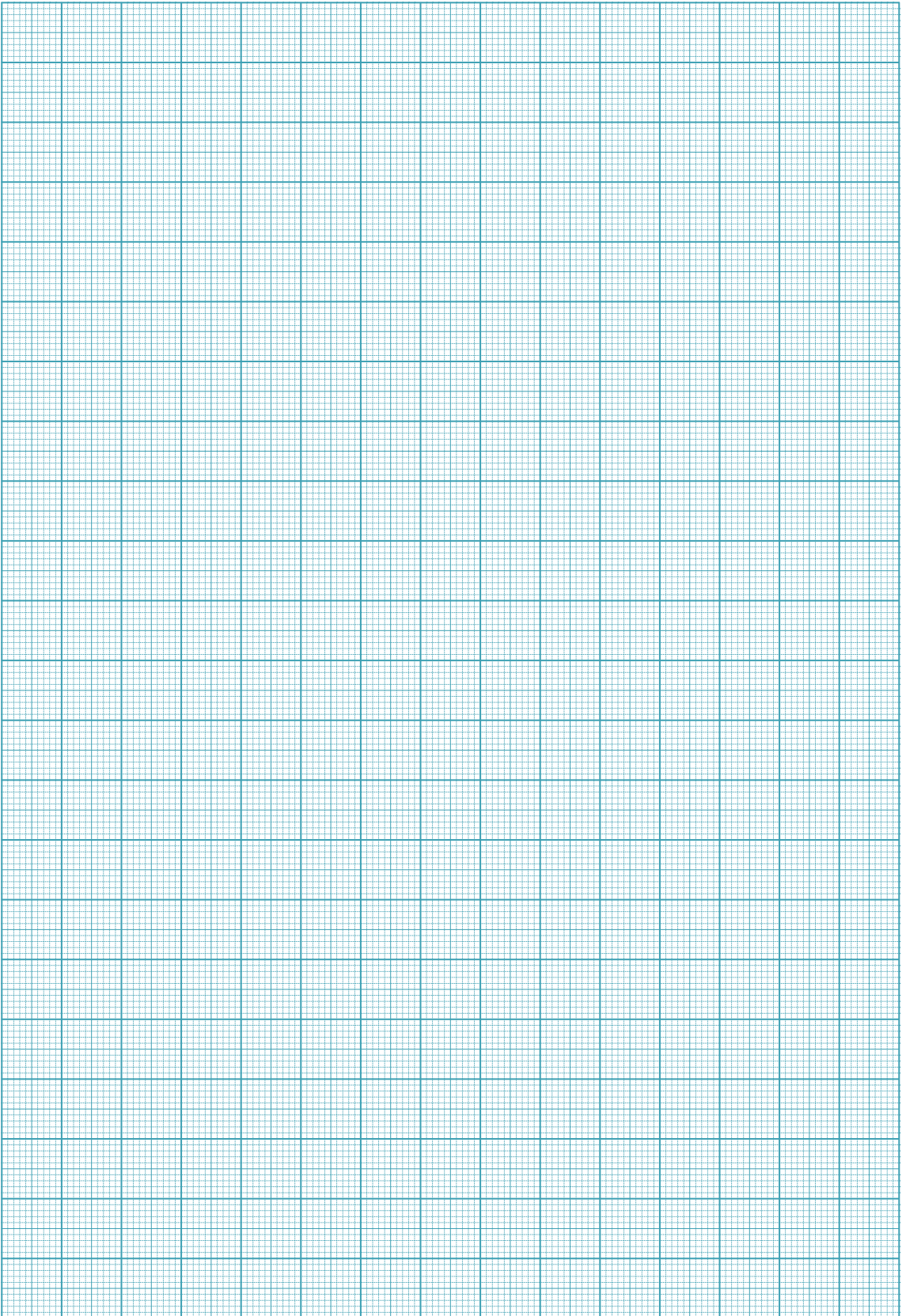

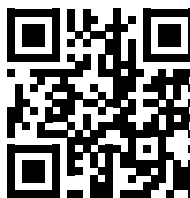

Link to the Multi-Brand Business Luminaires Online Shop at [www.KS-Light.co.uk](http://www.KS-Light.co.uk)

Your business advantages at KS Licht make your daily work easier.

Use our KS Multi-Brand Business luminaire online shop at [\*\*www.KS-Light.co.uk\*\*](http://www.KS-Light.co.uk) and benefit from the following advantages and functions:

- Current special offers and new products
- Online check of product availability
- Find and order all spare parts easily
- Quick order form for fast entry of your order
- All catalogues for downloading or as an online leaflet catalogue with product links
- Tender texts, light distribution curves/LDT plug-ins and quick calculation tables
- Simple product search through detailed filter functions
- Display of your individual purchasing conditions, delivery and payment terms
- Dropshipping delivery directly to your customers (delivery addresses can be entered online)
- Suitable product recommendations for lamps, accessories, drivers, electronic ballasts, etc.
- Display of alternative products and product families/variants
- Online chat with our consultants for your questions
- Online archive of your previous online orders
- Remaining stock offers at rock-bottom prices

---

**Confidential customer information:**

All prices are exclusive of VAT at the current rate of 19%.

The sales prices listed are recommended prices. The Euro prices serve as a calculation aid for the specialised trade. With the publication of this price list, the prices in all previously published price lists are no longer valid.

Our luminaire prices do not include lamps unless the product description indicates delivery with lamps. Lamp wattages refer to maximum values.

The illustrations and information contained in this catalogue are for illustrative purposes only and are non-binding in terms of colour, shape, design and technical data.

Dispatch is generally ex works and carriage forward.

Custom-made products of any kind, components of our delivery assortment assembled at the customer's request as well as lamps are excluded from exchange. For orders below an order value of € 70.00, a minimum quantity surcharge of € 8.00 will be charged.

When ordering, please always state the item number as well as the colour and quantity. This saves queries and errors.

For urgent orders, we offer you the following delivery methods, provided that the goods are available in stock and the order is received by 12.00 noon, we offer the following types of delivery:

- Over-night delivery by 10.30 a.m. or 12.00 p.m. in Germany using express shipping.
- Same-day delivery by direct drive to the destination.

We will be happy to inform you about the costs in individual cases.

Opening hours:

Monday - Thursday

from 08.00 to 16.30 hrs.

Friday

from 08.00 hrs to 15.00 hrs

During this time you can reach our **sales team** under the telephone number 0201-899 24-0.

For your **fax order** you can use the fax number 0201-899 24 124.

You can reach us by **email** at [\*\*Verkauf@KS-Germany.com\*\*](mailto:Verkauf@KS-Germany.com).

We will be happy to provide you with our general terms and conditions on request. You will also find them on the back of our letter and online at [www.ks-germany.com/de/agb](http://www.ks-germany.com/de/agb).

We do not recognise any conflicting terms and conditions of purchase.





KS Licht- u. Elektrotechnik GmbH  
Manderscheidstr. 8c  
D-45141 Essen

Tel.: +49 (0)201-89924-0  
Fax: +49 (0)201-89924-124

Internet: [www.KS-Germany.com](http://www.KS-Germany.com)  
Email: [Verkauf@KS-Germany.com](mailto:Verkauf@KS-Germany.com)